

**ADDENDUM NO. 1**  
**SW 320<sup>th</sup> STREET PRESERVATION**  
**PROJECT**  
**RFB# 20-008**  
**PROJECT #214**  
**FEDERAL AID #STPUL-1020(014)**  
**September 30, 2020**

**ATTENTION ALL BIDDERS AND PLANHOLDERS:** You are hereby notified that the Bid and Contract Documents are amended as follows:

**A) CONTRACT DOCUMENTS**

**(1) Bid Proposal**

Remove page RFB-10 and replace with the attached page RFB-10. The unit of measurement for crosswalk was incorrectly shown as SY. It is now correctly shown as SF to match the Special Provisions.

**(2) Plans**

Replace Sheet 02 – 06 with the attached sheets 02-06. Construction Notes references details on sheet “42 of 44” or “3 and 4”. Deleted “42 of 44” “3 and 4” and replaced with “04 of 25” and the Alternate Paving Patching detail was changed deleting the words “Jackhammer Out” and replacing with “Remove”.

**(3) Special Provisions, 1-07.23(1) Construction under Traffic (Page SP-54):**

Delete the first bulleted paragraph under January 5, 2015 WSDOT GSP, OPTION 5 and replace with the following two paragraphs:

- Only one lane of traffic (eastbound or westbound) may be closed to traffic between the hours of 7:00AM and 3:30PM with the exception of days when HMA pavement overlay occurs. Approval to close both one northbound and one southbound lane at the same time on non-expected days will require prior approval by the Project Engineer.
- On days when HMA Pavement overlay occur, lanes will be allowed to be reduced to one lane in each between the hours of 7:00AM and 5:30 PM.

**(4) Special Provisions, 2-03.(3) Removal of Pavement, Sidewalks, Curbs, and Gutters (Page SP-80):**

Delete the last sentence of the paragraph. Removal will be paid for under the appropriate Bid items in the Bid Proposal.

**B) PREVAILNG WAGE RATES**

The Davis Bacon Wage Rates have been updated. Delete the Davis Bacon wage rates provided and replace with the attached updated wage rates dated

September 11, 2020 into the Prevailing Wages and Benefit Code Key section of the Contract Documents.

**C) BID OPENING**

The bid opening date **has not** changed. All bidders are required to acknowledge receipt of this addendum on page RFB-12 of the Bid Form. Failure to do so may cause rejection of the bid.

**CITY OF FEDERAL WAY**

John Mulkey, P.E.

Senior Capital Engineer

38	8-09	RAISED PAVEMENT MARKER, TYPE 2	HUND	3.6	\$	\$
39	8-09	HYDRANT MARKER, TYPE 2B	EA	4	\$	\$
40	8-13	ADJUST MONUMENT CASE AND COVER	EA	8	\$	\$
41	8-14	CEMENT CONC. SIDEWALK	SY	485	\$	\$
42	8-14	CEMENT CONC. CURB RAMP TYPE 1 PARALLEL	EA	2	\$	\$
43	8-14	CEMENT CONC. CURB RAMP TYPE 2 PARALLEL	EA	2	\$	\$
44	8-14	CEMENT CONC. CURB RAMP TYPE SINGLE DIRECTION	EA	1	\$	\$
45	8-14	CEMENT CONC. CURB RAMP TYPE PERPENDICULAR	EA	1	\$	\$
46	8-14	UTILITY COVER NON-SLIP COATING	SF	27	\$	\$
47	8-21	PERMANENT SIGNING	LS	1	\$	\$
48	8-22	PROFILED PLASTIC LINE	LF	13790	\$	\$
49	8-22	PLASTIC CROSSWALK LINE	SF	320	\$	\$
50	8-22	PLASTIC TRAFFIC ARROW	EA	18	\$	\$
51	8-22	PLASTIC YIELD LINE SYMBOL	EA	78	\$	\$
52	8-22	REMOVAL OF PAVEMENT MARKINGS	LS	1	\$	\$
53	8-23	TEMPORARY PAVEMENT MARKING	LF	13790	\$	\$
54	8-23	TEMPORARY RAISED PAVEMENT MARKERS	HUND	3.6	\$	\$
55	8-23	REMOVAL OF TEMPORARY RAISED PAVEMENT MARKERS	HUND	3.6	\$	\$
<b>TOTAL – SCHEDULE A</b>						\$

CITY OF FEDERAL WAY

SW 320TH STREET PRESERVATION  
PROJECT

RFB-10

PROJECT #214 / RFB #20-008

\*\*\* PLAN CENTER COPY \*\*\* Official bid documents, plan notes, and addenda (if applicable) are available on BXWA.com

**NOTE:**





**CONTRACTOR TO INCLUDE FOLLOWING WORK IN BID**

1. ADJUST ALL STORM DRAINAGE MH'S, CB'S, MONUMENT BOXES AND OTHER STRUCTURES NOTED IN THE PLANS TO FINAL PAVEMENT GRADE AFTER OVERLAY. CONTRACTOR IS RESPONSIBLE FOR LOCATING ALL OTHER UTILITY APPURTENANCES IN THE AREAS TO BE PAVED.
2. LOCATION AND LIMITS OF CURB RAMP TO BE DETERMINED BY ENGINEER IN THE FIELD.
3. CONTRACTOR SHALL PROVIDE 72 HOURS NOTICE TO PROPERTY OWNERS TO ALLOW PARKING AND ACCESS TO RESIDENCES DURING PLANING AND PAVING OPERATIONS.
4. CONTRACTOR IS RESPONSIBLE FOR VERIFYING AND LAYING OUT ALL CHANNELIZATION WHICH SHALL BE APPROVED BY THE ENGINEER PRIOR TO INSTALLATION. ALL COSTS ASSOCIATED WITH THIS WORK SHALL BE INCIDENTAL TO VARIOUS BID ITEMS OF THE CONTRACT.
5. CONTRACTOR SHALL COORDINATE WORK WITH THE LOCAL GARBAGE DISPOSAL COMPANY TO AVOID CONFLICT.
6. CONTRACTOR SHALL COORDINATE WORK WITH TRANSIT PROVIDERS TO AVOID CONFLICT.

PAVEMENT MARKING CONSTRUCTION NOTES:

- 1 4" PROFILED PLASTIC TWO WAY LEFT TURN LANE LINE (MATERIAL TYPE D)
- 2 4" PROFILED PLASTIC LANE LINE (MATERIAL TYPE D)
- 3 4" PLASTIC LINE (MATERIAL TYPE D)
- 4 4" PROFILED PLASTIC DOUBLE YELLOW CENTERLINE (MATERIAL TYPE D)
- 5 8" PROFILED PLASTIC WIDE LINE (MATERIAL TYPE D)
- 6 PLASTIC TRAFFIC ARROW TYPE 2SL PER WSDOT STD. PLAN M-24.40-02 (MATERIAL TYPE A)
- 7 PLASTIC STOP LINE PER CFW DETAIL 3-21 (MATERIAL TYPE A)
- 8 PLASTIC CROSSWALK LINE PER CFW DETAIL 3-21 (MATERIAL TYPE A)
- 9 PAINT BIKE LANE SYMBOL PER WSDOT STD. PLAN M-9.50-02

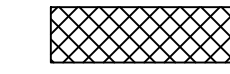





CONSTRUCTION NOTES:

-  = BUTT JOINT AT STATION OR LOCATION INDICATED. FULL DEPTH AT MATCH LINE AND TRANSITION TO 0" AT DISTANCE DIRECTED BY ENGINEER
-  = PLANE WIDTH AS INDICATED. FULL DEPTH AT FACE OF GUTTER
-  = DIG OUT AND REPAIR ROAD SECTION PER SECTIONS & DETAILS SHEET 03 OF 18
-  = CONCRETE WORK

- 1 SAWCUT ASPHALT PAVEMENT OR CONCRETE
- 2 ADJUST MANHOLE
- 3 ADJUST CATCH BASIN
- 4 INSTALL HEAVY DUTY FRAME AND LID PER SECTION 7-XX OF THE SPECIAL PROVISIONS
- 5 ADJUST MONUMENT CASE AND COVER
- 6 ADJUST UTILITY
- 7 ADJUST UTILITY BY OTHERS
- 8 CEMENT CONC. CURB RAMP TYPE 1 PARALLEL
- 9 CEMENT CONC. CURB RAMP TYPE 2 PARALLEL
- 10 CEMENT CONC. CURB RAMP TYPE SINGLE DIRECTION
- 11 CEMENT CONC. CURB RAMP TYPE 1 PERPENDICULAR
- 12 CEMENT CONC. CURB AND GUTTER
- 13 CEMENT CONC. SIDEWALK
- 14 CEMENT CONC. APPROACH
- 15 SOD, INCL. 4" TOPSOIL
- 16 CEMENT CONCRETE BARRIER CURB

\*\*\* PLAN CENTER COPY \*\*\* Official bid documents, plan holder's list, and addenda (if applicable) are available on BXWA.com

LEGEND:

- C/G = EXISTING CURB & GUTTER
- EP = EXISTING EDGE OF PAVEMENT
- TE = EXISTING THICKENED EDGE
-  = MONUMENT CASE
-  = EXISTING FIRE HYDRANT
-  = EXISTING STORM DRAIN CATCH BASIN
-  = EXISTING MANHOLE
-  = EXISTING STORM DRAIN MANHOLE
-  = EXISTING JUNCTION BOX
-  = INLET PROTECTION

K:\capital\projects\programmed\215 - SW 356th Preservation\03 PE\ACAD\36215\_GeneralSheets.dwg, 9/30/2020

BID SET



**CITY OF Federal Way**  
Centered on Opportunity  
33325 8TH AVE S FEDERAL WAY, WA 98003  
PHONE: (253) 835-2700  
WWW.CITYOFFEDERALWAY.COM



**811**  
Know what's below.  
Call before you dig.

DRAFTED: J. MULKEY  
DESIGNED: J. MULKEY  
REVIEWED: S. HAMEL  
APPROVED: D. WINKLER



DRAWING VERSION / REVISION LOG

NO.	DATE	REVISION

**PRESERVATION PROJECTS**

**GENERAL NOTES & LEGEND**  
**SW 320TH STREET & SW 356TH STREET**

CITY PROJECT #:  
**36214**

SHT. **02**  
OF **18**

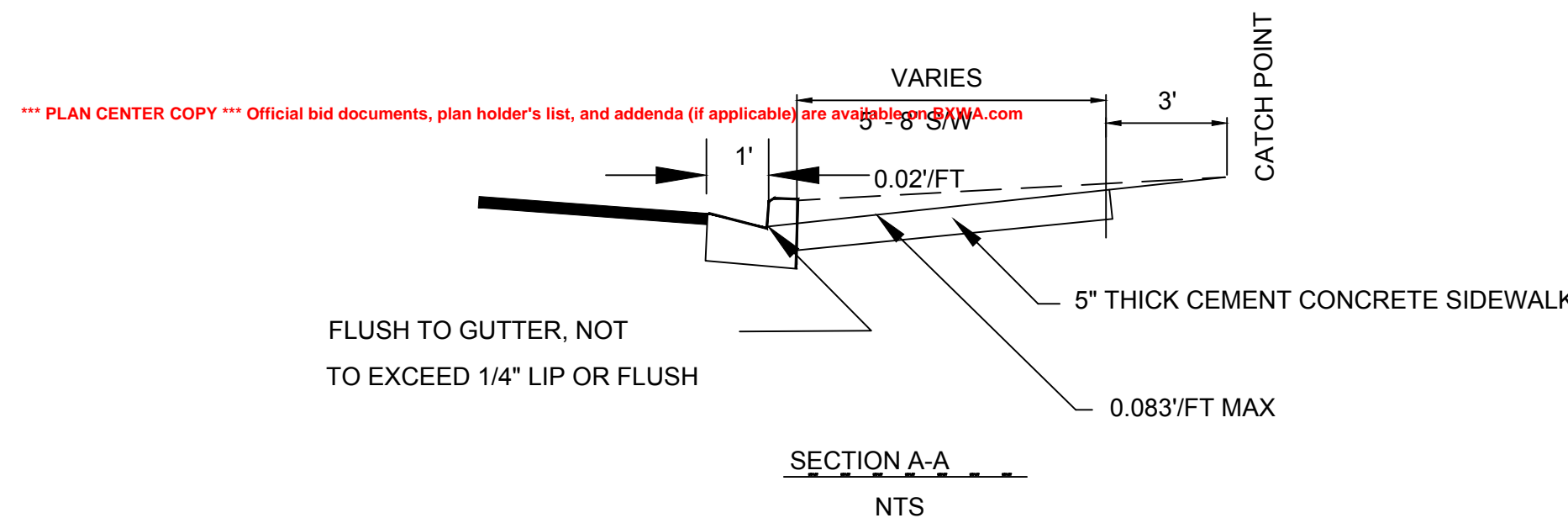
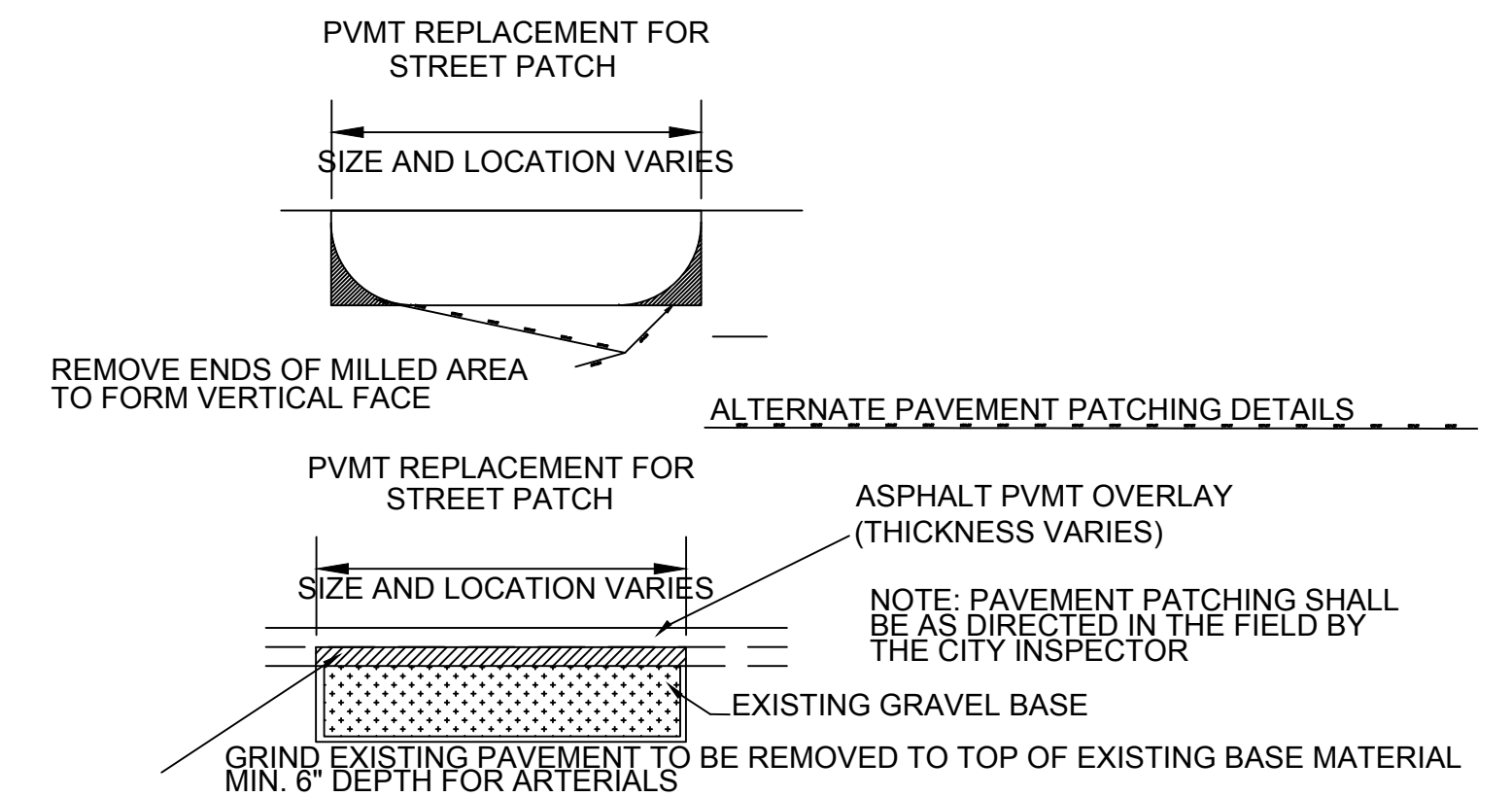
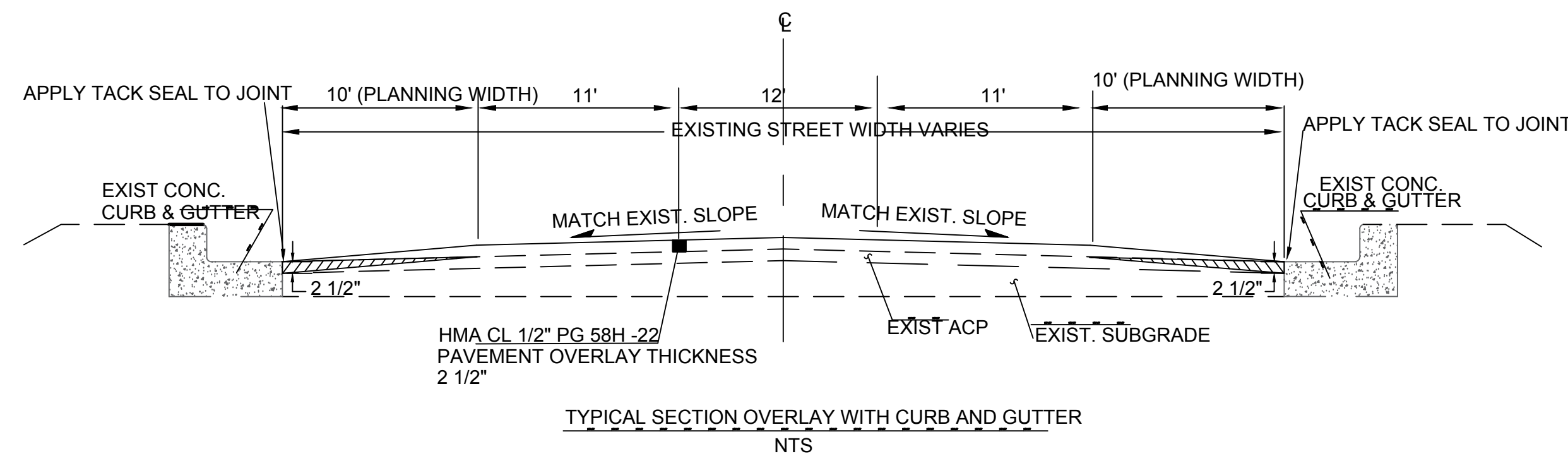
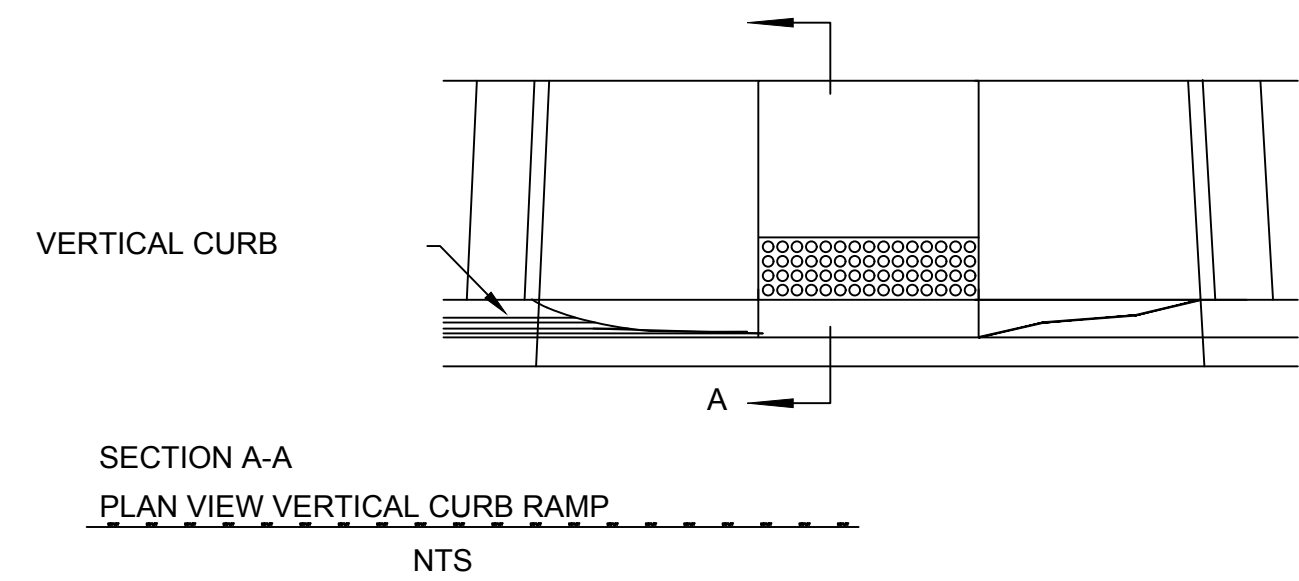
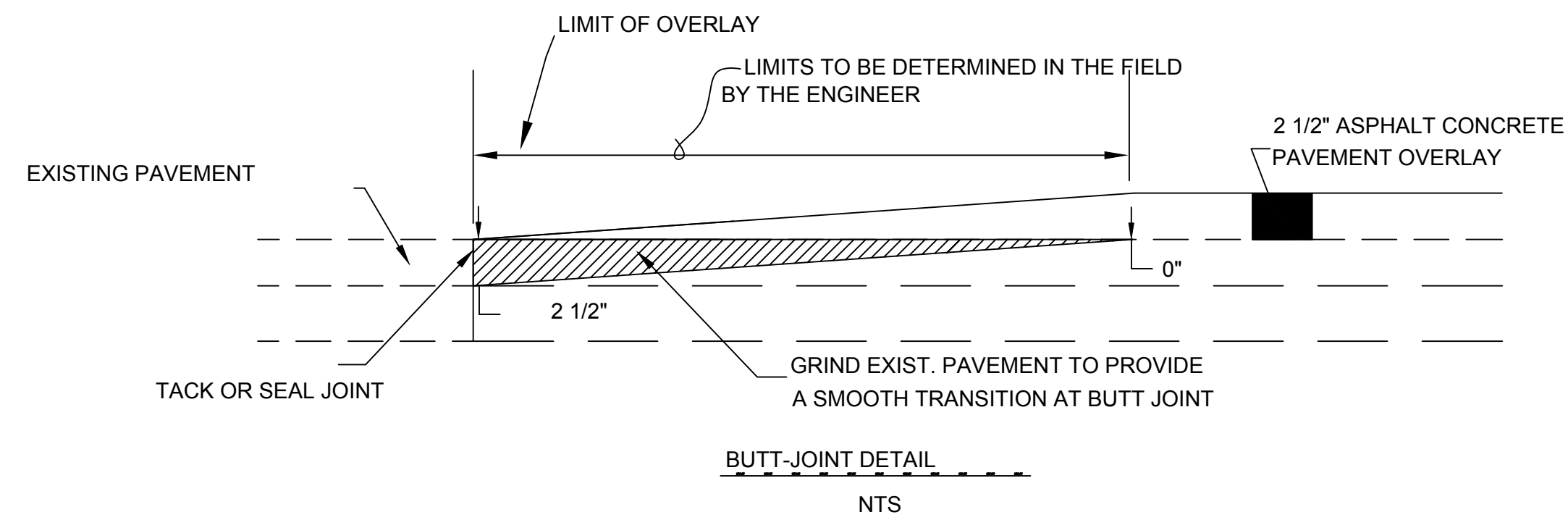
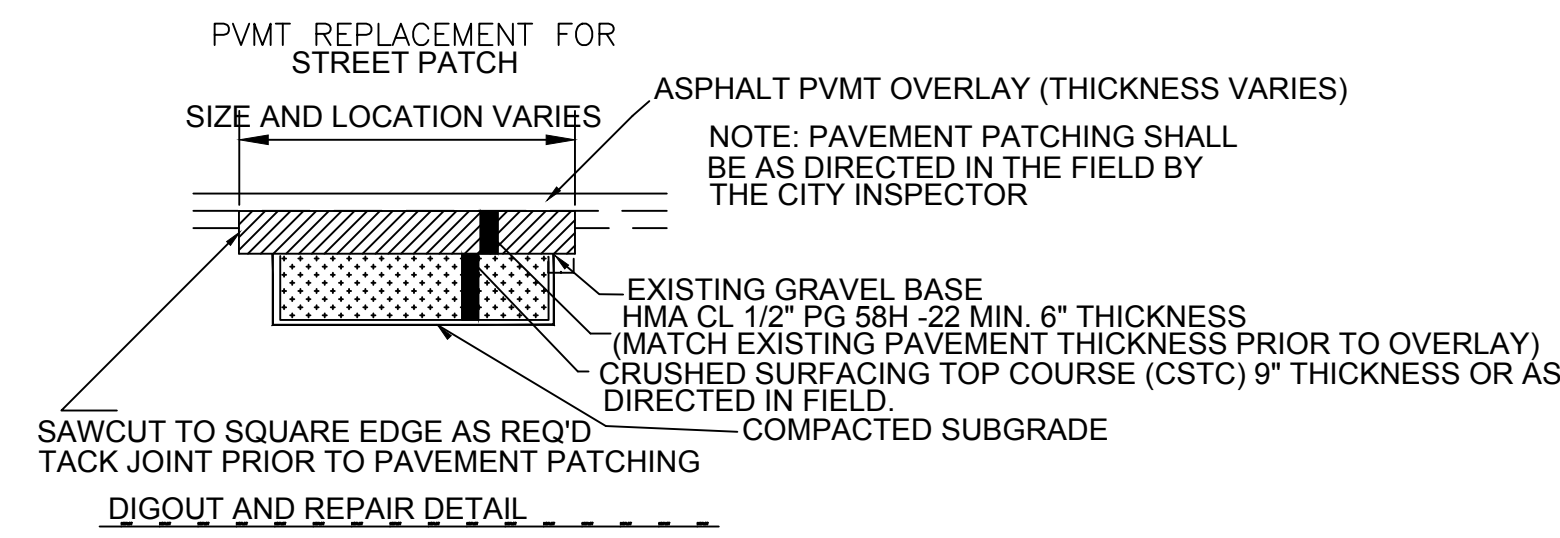

**NOTES FOR CURB RAMP REMOVAL AND REPLACEMENT:**

- EXISTING CURB RAMPS LOCATED AT INTERSECTIONS WITHIN THE LIMITS OF THE OVERLAY AREA SHALL BE REMOVED AND REPLACED WITH NEW CURB RAMPS CONFORMING TO THE REVISED STATE AND FEDERAL CRITERIA, AND THE DETAIL SHOWN.
- THE CITY OF FEDERAL WAY SHALL DESIGNATE THOSE RAMPS TO BE REMOVED AND RECONSTRUCTED. REMOVAL SHALL BE TO THE NEAREST JOINT. SAWCUT AT EXPANSION JOINT AS REQUIRED. REMOVE SIDEWALK AND CURB AND GUTTER AS REQUIRED TO OBTAIN ADEQUATE SPACING FOR NEW RAMP, TRANSITION, AND WARNING STRIP.
- FOR DIMENSIONS OF CURB RAMPS, REFER TO RAMP SHEETS. SPECIFICATIONS.

**RAMP NOTES:**

- RAMP AND APPROACHES SHALL BE CLEAR OF ALL OBSTACLES, INCLD HYDRANTS, POLES, AND INLETS.
- RAMP CENTERLINE SHALL BE PERPENDICULAR (OR RADIAL) TO CURB RETURNS.
- ON ARTERIAL STREETS, IN GENERAL CASE CURB RAMPS SHALL BE CONSTRUCTED TWO PER RADIUS, IN OR PREFERABLY ADJACENT TO THE MAIN PEDESTRIAN PATHS, AND SHALL BE ALIGNED WITH THE CROSSWALKS.
- ON RESIDENTIAL STREETS AND/OR WHEN UTILITIES ARE IN CONFLICT OR STREET GRADE EXCEEDS 4.0% CURB RAMPS MAY BE CONSTRUCTED ONE PER RADIUS, AT MIDPOINT OF CURB RETURN OR AT MAIN PEDESTRIAN PATH.

BID SET



DRAFTED: J. MULKEY  
DESIGNED: J. MULKEY  
REVIEWED: S. HAMEL  
APPROVED: D. WINKLER

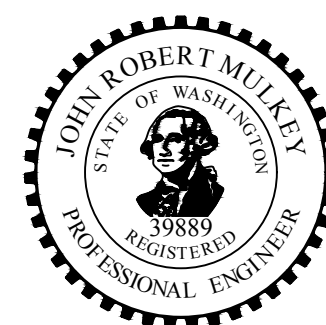

**DRAWING VERSION / REVISION LOG**

NO.	DATE	REVISION

**SW 320TH STREET PRESERVATION PROJECT**

**SECTIONS AND DETAILS**

CITY PROJECT #:  
36214

SHT. 03  
OF 18



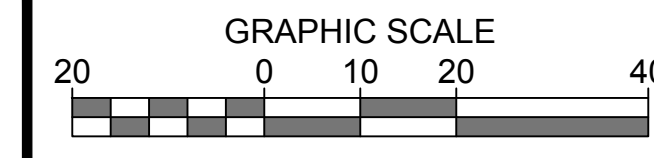

SITE PREP AND PAVING CONSTRUCTION NOTES:

- 1 SAWCUT ASPHALT PAVEMENT OR CONCRETE
- 2 ADJUST MANHOLE
- 3 ADJUST CATCH BASIN
- 4 INSTALL HEAVY DUTY FRAME AND LID PER SECTION 7-XX OF THE SPECIAL PROVISIONS
- 5 ADJUST MONUMENT CASE AND COVER
- 6 ADJUST WATER VALVE TO GRADE
- 7 ADJUST SANITARY SEWER MANHOLE TO GRADE
- 8 CEMENT CONC. CURB RAMP TYPE 1 PARALLEL
- 9 CEMENT CONC. CURB RAMP TYPE 2 PARALLEL
- 10 CEMENT CONC. CURB RAMP TYPE SINGLE DIRECTION
- 11 CEMENT CONC. CURB RAMP TYPE 1 PERPENDICULAR
- 12 CEMENT CONC. CURB AND GUTTER
- 13 CEMENT CONC. SIDEWALK
- 14 CEMENT CONC. APPROACH
- 15 SOD, INCL. 4" TOPSOIL
- 16 TYPE 1 CATCH BASIN WITH THROUGH CURB INLET
- 17 CONNECT TO EXISTING PIPE
- 18 ADJUST WATER VAULT TO GRADE
- 19 UTILITY NON-SLIP COATING
- 20 CEMENT CONCRETE BARRIER CURB PER COFW DETAIL 3-04

LEGEND:

- C/G = EXISTING CURB & GUTTER
- EP = EXISTING EDGE OF PAVEMENT
- TE = EXISTING THICKENED EDGE
- MC = MONUMENT CASE
- FH = EXISTING FIRE HYDRANT
- SDCB = EXISTING STORM DRAIN CATCH BASIN
- SM = EXISTING MANHOLE
- SDM = EXISTING STORM DRAIN MANHOLE
- JB = EXISTING JUNCTION BOX
- IP = INLET PROTECTION
- GV = GAS VALVE
- [Hatched Box] = BUTT JOINT AT STATION OR LOCATION INDICATED. FULL DEPTH AT MATCH LINE AND TRANSITION TO 0" AT DISTANCE DIRECTED BY ENGINEER
- [Dotted Box] = PLANE WIDTH AS INDICATED. FULL DEPTH AT FACE OF GUTTER
- [Cross-hatched Box] = DIG OUT AND REPAIR ROAD SECTION PER SECTIONS & DETAILS SHEET 3 OF 18
- [Stippled Box] = CONCRETE WORK

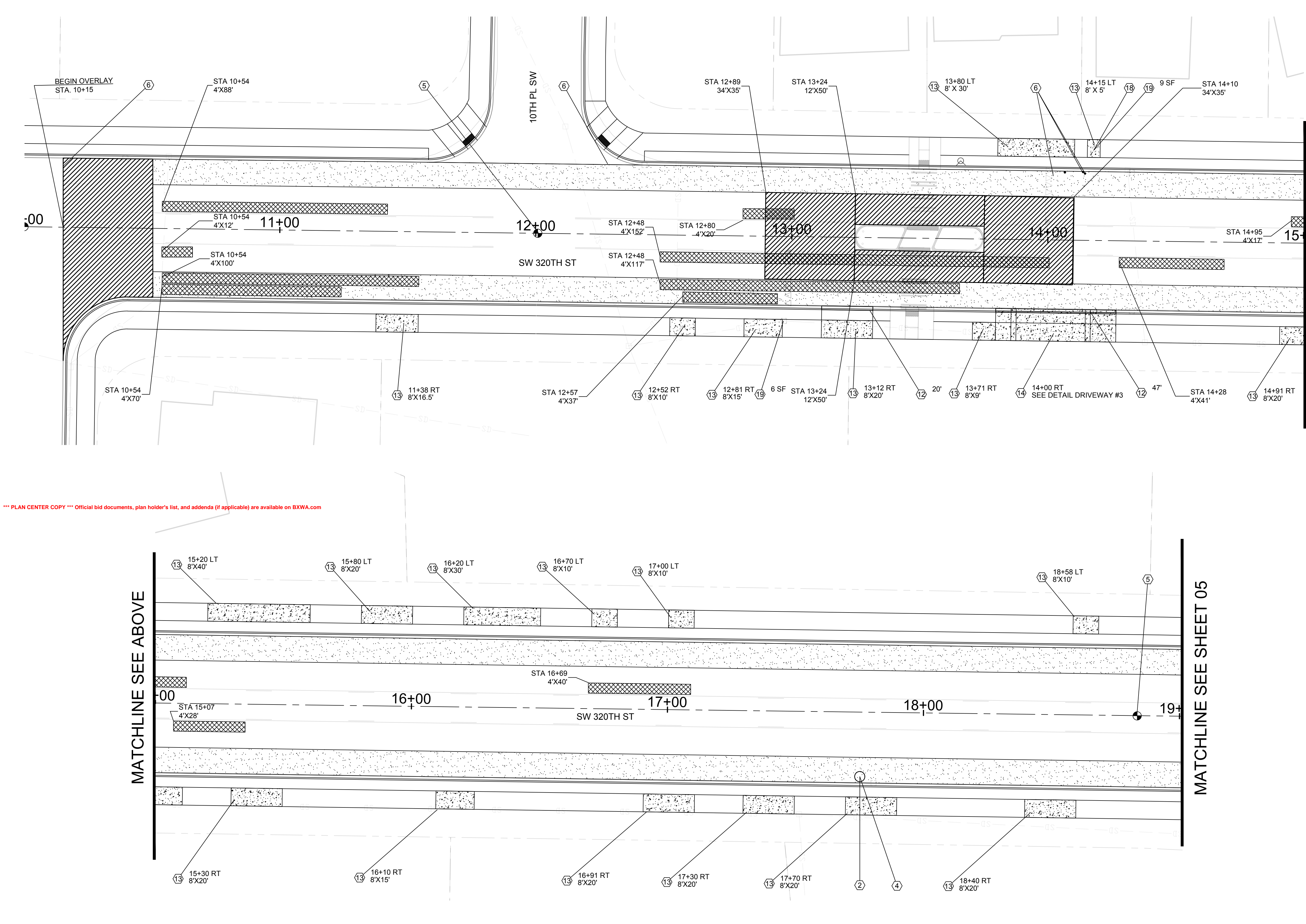

\*\*\* PLAN CENTER COPY \*\*\* Official bid documents, plan holder's list, and addenda (if applicable) are available on BXWA.com

K:\capital\projects\programmed\214 - sw 320th preservation\03 PE\ACAD\36214 - SitePrepAndPavingSheets.dwg, 9/10/2020

BID SET



DRAFTED: J. MULKEY  
 DESIGNED: J. MULKEY  
 REVIEWED: S. HAMEL  
 APPROVED: D. WINKLER



DRAWING VERSION / REVISION LOG

NO.	DATE	REVISION

SW 320TH STREET PRESERVATION PROJECT

SITE PREP AND PAVING PLAN  
 STA 10+00 TO 19+00

CITY PROJECT #:  
 36214  
 SHT. 04  
 OF 18



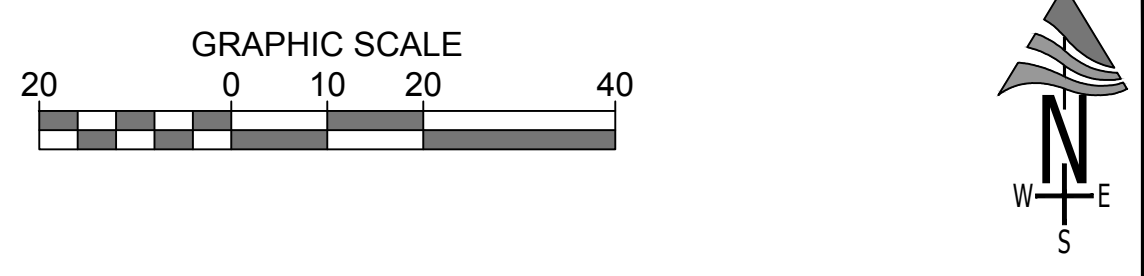
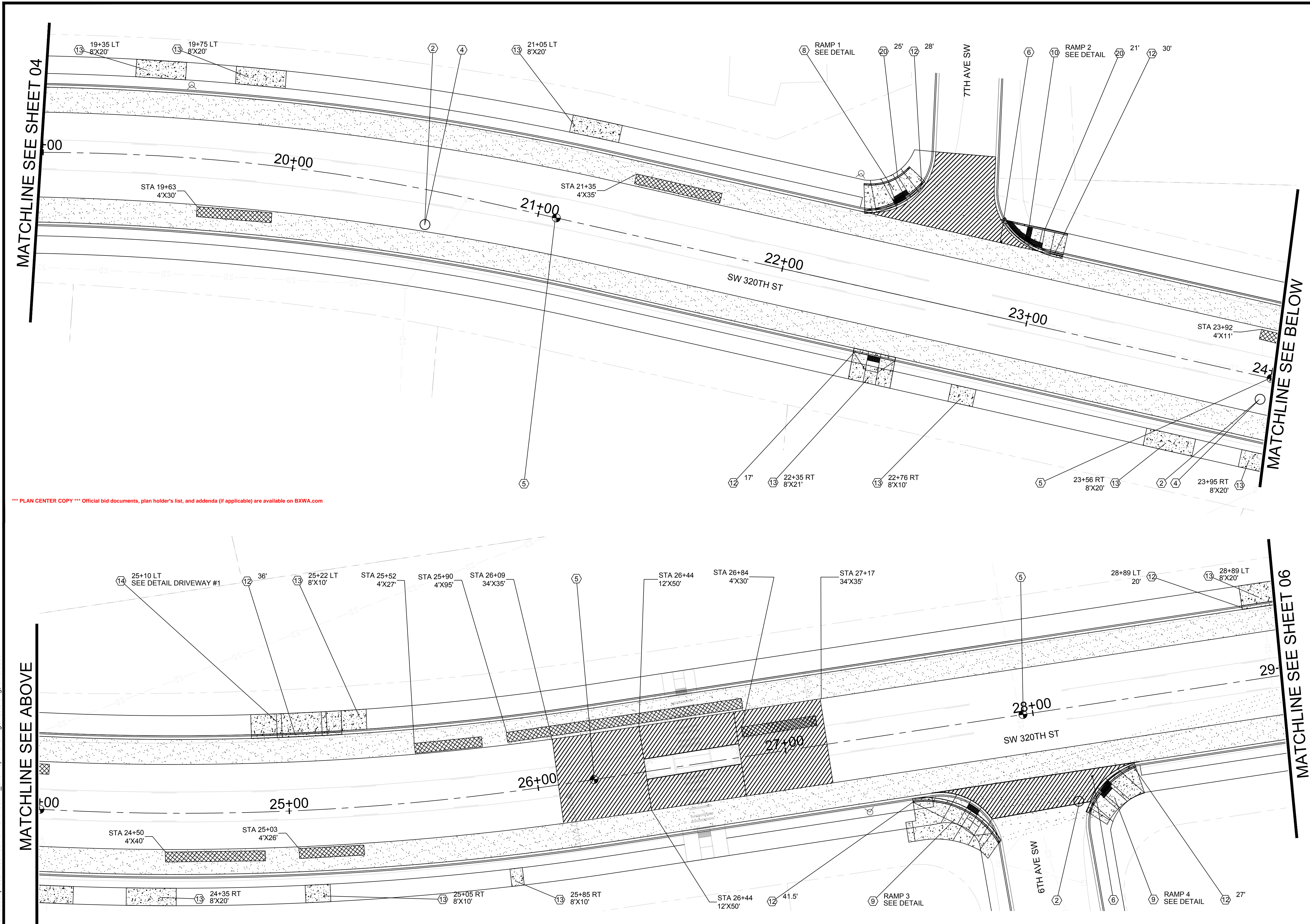

- SITE PREP AND PAVING CONSTRUCTION NOTES:**
- 1 SAWCUT ASPHALT PAVEMENT OR CONCRETE
  - 2 ADJUST MANHOLE
  - 3 ADJUST CATCH BASIN
  - 4 INSTALL HEAVY DUTY FRAME AND LID PER SECTION 7-XX OF THE SPECIAL PROVISIONS
  - 5 ADJUST MONUMENT CASE AND COVER
  - 6 ADJUST WATER VALVE TO GRADE
  - 7 ADJUST SANITARY SEWER MANHOLE TO GRADE
  - 8 CEMENT CONC. CURB RAMP TYPE 1 PARALLEL
  - 9 CEMENT CONC. CURB RAMP TYPE 2 PARALLEL
  - 10 CEMENT CONC. CURB RAMP TYPE SINGLE DIRECTION
  - 11 CEMENT CONC. CURB RAMP TYPE 1 PERPENDICULAR
  - 12 CEMENT CONC. CURB AND GUTTER
  - 13 CEMENT CONC. SIDEWALK
  - 14 CEMENT CONC. APPROACH
  - 15 SOD, INCL. 4" TOPSOIL
  - 16 TYPE 1 CATCH BASIN WITH THROUGH CURB INLET
  - 17 CONNECT TO EXISTING PIPE
  - 18 ADJUST WATER VAULT TO GRADE
  - 19 UTILITY NON-SLIP COATING
  - 20 CEMENT CONCRETE BARRIER CURB PER COFW DETAIL 3-04

- LEGEND:**
- C/G = EXISTING CURB & GUTTER
  - EP = EXISTING EDGE OF PAVEMENT
  - TE = EXISTING THICKENED EDGE
  - MC = MONUMENT CASE
  - FH = EXISTING FIRE HYDRANT
  - SDCB = EXISTING STORM DRAIN CATCH BASIN
  - SM = EXISTING MANHOLE
  - SDSM = EXISTING STORM DRAIN MANHOLE
  - JB = EXISTING JUNCTION BOX
  - IP = INLET PROTECTION
  - GV = GAS VALVE
  - BJ = BUTT JOINT AT STATION OR LOCATION INDICATED. FULL DEPTH AT MATCH LINE AND TRANSITION TO 0" AT DISTANCE DIRECTED BY ENGINEER
  - PL = PLANE WIDTH AS INDICATED. FULL DEPTH AT FACE OF GUTTER
  - DR = DIG OUT AND REPAIR ROAD SECTION PER SECTIONS & DETAILS SHEET 3 OF 18
  - CC = CONCRETE WORK

\*\*\* PLAN CENTER COPY \*\*\* Official bid documents, plan holder's list, and addenda (if applicable) are available on BXWA.com

K:\capital\projects\programmed\214 - sw 320th preservation\03 PE\ACAD\36214 - SitePrepAndPavingSheets.dwg, 9/10/2020

**CITY OF Federal Way**  
 Centered on Opportunity  
 33325 8TH AVE S FEDERAL WAY, WA 98003  
 PHONE: (253) 835-2700  
 WWW.CITYOFFEDERALWAY.COM



DRAFTED: J. MULKEY  
 DESIGNED: J. MULKEY  
 REVIEWED: S. HAMEL  
 APPROVED: D. WINKLER



DRAWING VERSION / REVISION LOG		
NO.	DATE	REVISION

**BID SET**

**SW 320TH STREET PRESERVATION PROJECT**

**SITE PREP AND PAVING PLAN**

**STA 19+00 TO 29+00**

CITY PROJECT #:  
**36214**

SHT. **05**  
 OF **18**



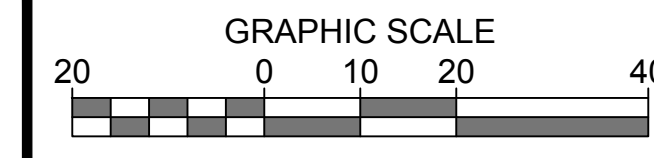

**SITE PREP AND PAVING CONSTRUCTION NOTES:**

- 1 SAWCUT ASPHALT PAVEMENT OR CONCRETE
- 2 ADJUST MANHOLE
- 3 ADJUST CATCH BASIN
- 4 INSTALL HEAVY DUTY FRAME AND LID PER SECTION 7-XX OF THE SPECIAL PROVISIONS
- 5 ADJUST MONUMENT CASE AND COVER
- 6 ADJUST WATER VALVE TO GRADE
- 7 ADJUST SANITARY SEWER MANHOLE TO GRADE
- 8 CEMENT CONC. CURB RAMP TYPE 1 PARALLEL
- 9 CEMENT CONC. CURB RAMP TYPE 2 PARALLEL
- 10 CEMENT CONC. CURB RAMP TYPE SINGLE DIRECTION
- 11 CEMENT CONC. CURB RAMP TYPE 1 PERPENDICULAR
- 12 CEMENT CONC. CURB AND GUTTER
- 13 CEMENT CONC. SIDEWALK
- 14 CEMENT CONC. APPROACH
- 15 SOD, INCL. 4" TOPSOIL
- 16 TYPE 1 CATCH BASIN WITH THROUGH CURB INLET
- 17 CONNECT TO EXISTING PIPE
- 18 ADJUST WATER VAULT TO GRADE
- 19 UTILITY NON-SLIP COATING
- 20 CEMENT CONCRETE BARRIER CURB PER COFW DETAIL 3-04

- LEGEND:**
- C/G = EXISTING CURB & GUTTER
  - EP = EXISTING EDGE OF PAVEMENT
  - TE = EXISTING THICKENED EDGE
  - ⊙ = MONUMENT CASE
  - ⊕ = EXISTING FIRE HYDRANT
  - ⊕ = EXISTING STORM DRAIN CATCH BASIN
  - ⊕ = EXISTING MANHOLE
  - ⊕ = EXISTING STORM DRAIN MANHOLE
  - ⊕ = EXISTING JUNCTION BOX
  - ⊕ = INLET PROTECTION
  - ⊕ = GAS VALVE
  - [Hatched Box] = BUTT JOINT AT STATION OR LOCATION INDICATED. FULL DEPTH AT MATCH LINE AND TRANSITION TO 0" AT DISTANCE DIRECTED BY ENGINEER
  - [Dotted Box] = PLANE WIDTH AS INDICATED. FULL DEPTH AT FACE OF GUTTER
  - [Cross-hatched Box] = DIG OUT AND REPAIR ROAD SECTION PER SECTIONS & DETAILS SHEET 3 OF 18
  - [Stippled Box] = CONCRETE WORK

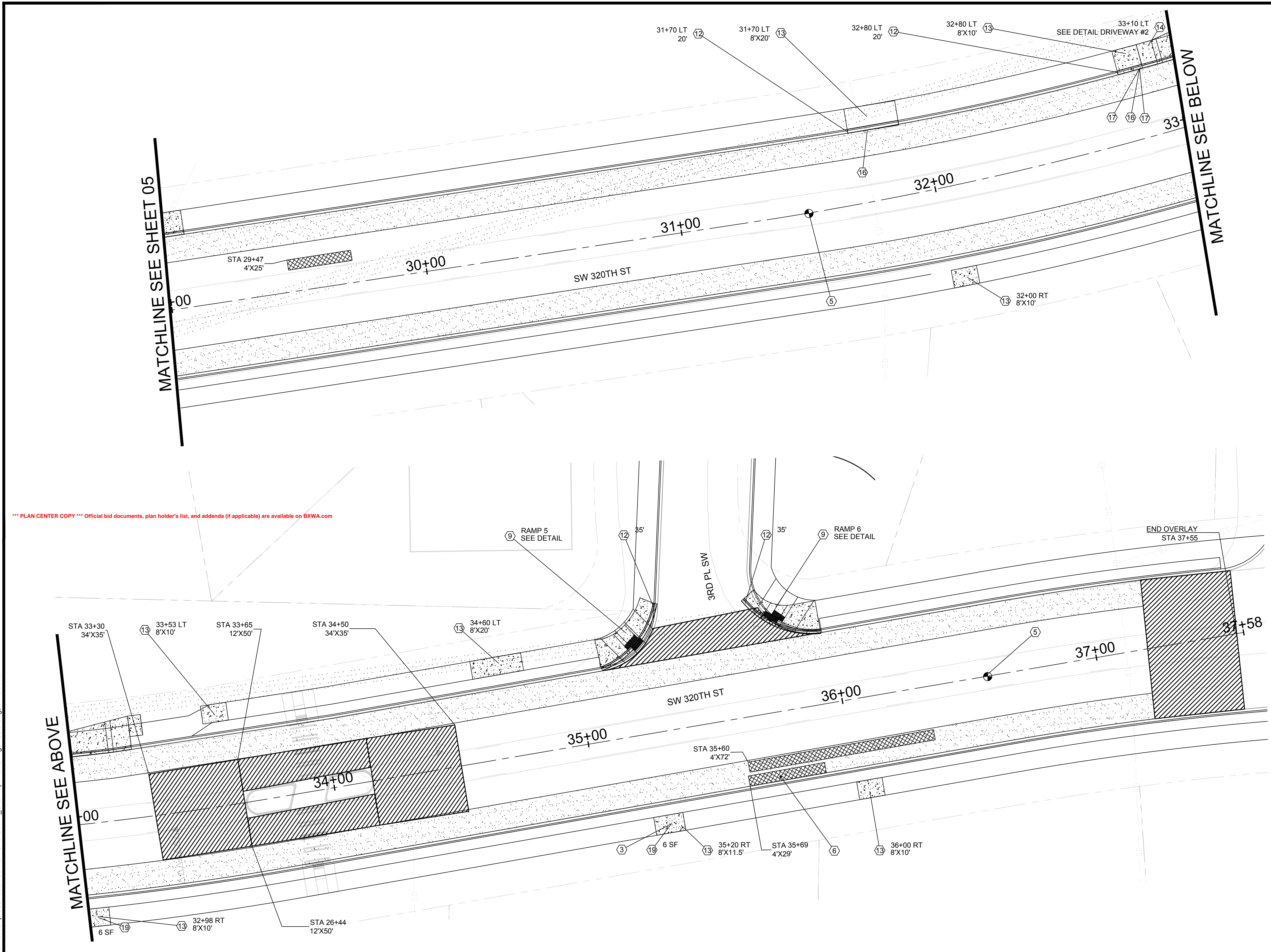

\*\*\* PLAN CENTER COPY \*\*\* Official bid documents, plan holder's list, and addenda (if applicable) are available on BXWA.com

K:\capital\projects\programmed\214 - sw 320th preservation\03 PE\ACAD\36214 - SitePrepAndPavingSheets.dwg, 9/10/2020

33325 8TH AVE S FEDERAL WAY, WA 98003  
PHONE: (253) 835-2700  
WWW.CITYOFFEDERALWAY.COM



DRAFTED: J. MULKEY  
DESIGNED: J. MULKEY  
REVIEWED: S. HAMEL  
APPROVED: D. WINKLER



DRAWING VERSION / REVISION LOG		
NO.	DATE	REVISION

# SW 320TH STREET PRESERVATION PROJECT

## SITE PREP AND PAVING STA 29+00 TO 38+00

**BID SET**  
CITY PROJECT #:  
**36214**  
SHT. **06**  
OF **18**



"General Decision Number: WA20200001 09/11/2020

Superseded General Decision Number: WA20190001

State: Washington

Construction Type: Highway

Counties: Washington Statewide.

HIGHWAY (Excludes D.O.E. Hanford Site in Benton and Franklin Counties)

Note: Under Executive Order (EO) 13658, an hourly minimum wage of \$10.80 for calendar year 2020 applies to all contracts subject to the Davis-Bacon Act for which the contract is awarded (and any solicitation was issued) on or after January 1, 2015. If this contract is covered by the EO, the contractor must pay all workers in any classification listed on this wage determination at least \$10.80 per hour (or the applicable wage rate listed on this wage determination, if it is higher) for all hours spent performing on the contract in calendar year 2020. If this contract is covered by the EO and a classification considered necessary for performance of work on the contract does not appear on this wage determination, the contractor must pay workers in that classification at least the wage rate determined through the conformance process set forth in 29 CFR 5.5(a)(1)(ii) (or the EO minimum wage rate, if it is higher than the conformed wage rate). The EO minimum wage rate will be adjusted annually. Please note that this EO applies to the above-mentioned types of contracts entered into by the federal government that are subject to the Davis-Bacon Act itself, but it does not apply to contracts subject only to the Davis-Bacon Related Acts, including those set forth at 29 CFR 5.1(a)(2)-(60). Additional information on contractor requirements and worker protections under the EO is available at [www.dol.gov/whd/govcontracts](http://www.dol.gov/whd/govcontracts).

Modification Number	Publication Date
0	01/03/2020
1	02/14/2020
2	02/28/2020
3	03/06/2020
4	03/13/2020
5	05/01/2020
6	07/03/2020
7	07/10/2020
8	07/24/2020
9	08/07/2020
10	08/14/2020
<b>11</b>	<b>09/11/2020</b>

CARP0003-006 06/01/2018

SOUTHWEST WASHINGTON: CLARK, COWLITZ, KLICKITAT, LEWIS (Piledriver only), PACIFIC (South of a straight line made by extending the north boundary line of Wahkiakum County west to Willapa Bay to the Pacific Ocean), SKAMANIA, and WAHKIAKUM Counties.

	Rates	Fringes
Carpenters:		
CARPENTERS.....	\$ 37.64	16.83
DIVERS TENDERS.....	\$ 43.73	16.83
DIVERS.....	\$ 87.73	16.83
DRYWALL.....	\$ 37.64	16.83
MILLWRIGHTS.....	\$ 38.17	16.83
PILEDRIVERS.....	\$ 38.71	16.83

DEPTH PAY:

50 TO 100 FEET \$1.00 PER FOOT OVER 50 FEET  
 101 TO 150 FEET \$1.50 PER FOOT OVER 101 FEET  
 151 TO 200 FEET \$2.00 PER FOOT OVER 151 FEET

Zone Differential (Add up Zone 1 rates):

Zone 2 - \$0.85  
 Zone 3 - 1.25  
 Zone 4 - 1.70  
 Zone 5 - 2.00  
 Zone 6 - 3.00

BASEPOINTS: ASTORIA, LONGVIEW, PORTLAND, THE DALLES, AND VANCOUVER, (NOTE: All dispatches for Washington State Counties: Cowlitz, Wahkiakum and Pacific shall be from Longview Local #1707 and mileage shall be computed from that point.)

ZONE 1: Projects located within 30 miles of the respective city hall of the above mentioned cities  
 ZONE 2: Projects located more than 30 miles and less than 40 miles of the respective city of the above mentioned cities  
 ZONE 3: Projects located more than 40 miles and less than 50 miles of the respective city of the above mentioned cities  
 ZONE 4: Projects located more than 50 miles and less than 60 miles of the respective city of the above mentioned cities.  
 ZONE 5: Projects located more than 60 miles and less than 70 miles of the respective city of the above mentioned cities  
 ZONE 6: Projects located more than 70 miles of the respected city of the above mentioned cities

-----



CARP0030-004 06/01/2019

CLALLAM, GRAYS HARBOR, ISLAND, JEFFERSON, KING, KITSAP, LEWIS, MASON, PACIFIC (North of a straight line made by extending the north boundary line of Wahkiakum County west to the Pacific Ocean), PIERCE, SAN JUAN, SKAGIT, SNOHOMISH, THURSTON AND WHATCOM Counties

	Rates	Fringes
CARPENTER		
BRIDGE CARPENTERS.....	\$ 45.92	16.52
CARPENTERS ON CREOSOTE MATERIAL.....	\$ 46.02	16.52
CARPENTERS.....	\$ 45.92	16.52
DIVERS TENDER.....	\$ 50.79	16.52
DIVERS.....	\$ 99.68	16.52
MILLWRIGHT AND MACHINE ERECTORS.....	\$ 47.42	16.52
PILEDRIVER, DRIVING, PULLING, CUTTING, PLACING COLLARS, SETTING, WELDING OR CRESOTE TREATED MATERIAL, ALL PILING.....	\$ 46.17	16.52

(HOURLY ZONE PAY: WESTERN AND CENTRAL WASHINGTON - ALL CLASSIFICATIONS EXCEPT MILLWRIGHTS AND PILEDRIVERS

Hourly Zone Pay shall be paid on jobs located outside of the free zone computed from the city center of the following listed cities:

Seattle	Olympia	Bellingham
Auburn	Bremerton	Anacortes
Renton	Shelton	Yakima
Aberdeen-Hoquiam	Tacoma	Wenatchee
Ellensburg	Everett	Port Angeles
Centralia	Mount Vernon	Sunnyside
Chelan	Pt. Townsend	

Zone Pay:

0 -25 radius miles	Free
26-35 radius miles	\$1.00/hour
36-45 radius miles	\$1.15/hour
46-55 radius miles	\$1.35/hour
Over 55 radius miles	\$1.55/hour

(HOURLY ZONE PAY: WESTERN AND CENTRAL WASHINGTON - MILLWRIGHT AND PILEDRIVER ONLY)

Hourly Zone Pay shall be computed from Seattle Union Hall, Tacoma City center, and Everett City center

Zone Pay:

0 -25 radius miles	Free
26-45 radius miles	\$ .70/hour
Over 45 radius miles	\$1.50/hour

-----  
 CARP0059-002 06/01/2019

ADAMS, ASOTIN, BENTON, CHELAN (East of 120th meridian),  
 COLUMBIA, DOUGLAS, FERRY, FRANKLIN, GARFIELD, GRANT (East of  
 120th meridian), KITTITAS (East of 120th meridian), LINCOLN,  
 OKANOGAN (East of 120th meridian), PEND OREILLE, SPOKANE,  
 STEVENS, WALLA WALLA, WHITMAN, and YAKIMA (East of 120th  
 meridian) Counties

	Rates	Fringes
CARPENTER		
GROUP 1.....	\$ 35.47	16.88
GROUP 2.....	\$ 47.42	18.96
GROUP 3.....	\$ 36.66	16.88
GROUP 4.....	\$ 36.66	16.88
GROUP 5.....	\$ 83.96	16.88
GROUP 6.....	\$ 40.23	16.88
GROUP 7.....	\$ 41.23	16.88
GROUP 8.....	\$ 37.66	16.88
GROUP 9.....	\$ 44.23	16.88

CARPENTER & DIVER CLASSIFICATIONS:

GROUP 1: Carpenter

GROUP 2: Millwright, Machine Erector

GROUP 3: Piledriver - includes driving, pulling, cutting,  
 placing collars, setting, welding, or creosote treated  
 material, on all piling

GROUP 4: Bridge, Dock, and Wharf carpenters

GROUP 5: Diver Wet

GROUP 6: Diver Tender, Manifold Operator, ROV Operator

GROUP 7: Diver Standby

GROUP 8: Assistant Diver Tender, ROV Tender/Technician

GROUP 9: Manifold Operator-Mixed Gas

ZONE PAY:

ZONE 1	0-45 MILES	FREE
ZONE 2	45-100	\$4.00/PER HOUR
ZONE 3	OVER 100 MILES	\$6.00/PER HOUR



DISPATCH POINTS:

CARPENTERS/MILLWRIGHTS: PASCO (515 N Neel Street) or Main Post Office of established residence of employee (Whichever is closest to the worksite).

CARPENTERS/PILEDRIIVER: SPOKANE (127 E. AUGUSTA AVE.) or Main Post Office of established residence of employee (Whichever is closest to the worksite).

CARPENTERS: WENATCHEE (27 N. CHELAN) or Main Post Office of established residence of employee (Whichever is closest to the worksite).

CARPENTERS: COEUR D' ALENE (1839 N. GOVERNMENT WAY) or Main Post Office of established residence of employee (Whichever is closest to the worksite).

CARPENTERS: MOSCOW (306 N. JACKSON) or Main Post Office of established residence of employee (Whichever is closest to the worksite).

DEPTH PAY FOR DIVERS BELOW WATER SURFACE:

50-100 feet \$2.00 per foot  
101-150 feet \$3.00 per foot  
151-220 feet \$4.00 per foot  
221 feet and deeper \$5.00 per foot

PREMIUM PAY FOR DIVING IN ENCLOSURES WITH NO VERTICAL ASCENT:

0-25 feet Free  
26-300 feet \$1.00 per Foot

SATURATION DIVING:

The standby rate applies until saturation starts. The saturation diving rate applies when divers are under pressure continuously until work task and decompression are complete. the diver rate shall be paid for all saturation hours.

WORK IN COMBINATION OF CLASSIFICATIONS:

Employees working in any combination of classifications within the diving crew (except dive supervisor) in a shift are paid in the classification with the highest rate for that shift.

HAZMAT PROJECTS:

Anyone working on a HAZMAT job (task), where HAZMAT certification is required, shall be compensated at a premium, in addition to the classification working in as follows:

LEVEL D + \$.25 per hour - This is the lowest level of protection. No respirator is used and skin protection is minimal.

LEVEL C + \$.50 per hour - This level uses an air purifying respirator or additional protective clothing.

LEVEL B + \$.75 per hour - Uses same respirator protection as Level A. Supplied air line is provided in conjunction with a chemical "splash suit".

LEVEL A +\$1.00 per hour - This level utilizes a fully encapsulated suit with a self-contained breathing apparatus or a supplied air line.

-----  
 CARP0770-003 06/01/2019

WEST OF 120TH MERIDIAN FOR THE FOLLOWING COUNTIES:  
 CHELAN, DOUGLAS, GRANT, KITTITAS, OKANOGAN, and YAKIMA

	Rates	Fringes
CARPENTER		
CARPENTERS ON CREOSOTE		
MATERIAL.....	\$ 46.02	16.52
CARPENTERS.....	\$ 45.92	16.52
DIVERS TENDER.....	\$ 50.79	16.52
DIVERS.....	\$ 99.68	16.52
MILLWRIGHT AND MACHINE		
ERECTORS.....	\$ 47.42	16.52
PILEDRIVER, DRIVING, PULLING, CUTTING, PLACING COLLARS, SETTING, WELDING OR CRESOTE TREATED		
MATERIAL, ALL PILING.....	\$ 46.17	16.52

(HOURLY ZONE PAY: WESTERN AND CENTRAL WASHINGTON - ALL CLASSIFICATIONS EXCEPT MILLWRIGHTS AND PILEDRIVERS

Hourly Zone Pay shall be paid on jobs located outside of the free zone computed from the city center of the following listed cities:

Seattle	Olympia	Bellingham
Auburn	Bremerton	Anacortes
Renton	Shelton	Yakima
Aberdeen-Hoquiam	Tacoma	Wenatchee
Ellensburg	Everett	Port Angeles
Centralia	Mount Vernon	Sunnyside
Chelan	Pt. Townsend	

Zone Pay:

0 -25 radius miles	Free
26-35 radius miles	\$1.00/hour
36-45 radius miles	\$1.15/hour
46-55 radius miles	\$1.35/hour
Over 55 radius miles	\$1.55/hour



(HOURLY ZONE PAY: WESTERN AND CENTRAL WASHINGTON - MILLWRIGHT AND PILEDRIVER ONLY)

Hourly Zone Pay shall be computed from Seattle Union Hall, Tacoma City center, and Everett City center

Zone Pay:  
 0 -25 radius miles Free  
 26-45 radius miles \$ .70/hour  
 Over 45 radius miles \$1.50/hour

---

\* **ELEC0046-001 08/03/2020**

CALLAM, JEFFERSON, KING AND KITSAP COUNTIES

	Rates	Fringes
CABLE SPLICER.....	\$ 59.91	3%+21.46
<b>ELECTRICIAN.....</b>	<b>\$ 58.78</b>	<b>3%+22.51</b>

---

\* ELEC0048-003 01/01/2020

CLARK, KLUCKITAT AND SKAMANIA COUNTIES

	Rates	Fringes
CABLE SPLICER.....	\$ 44.22	21.50
ELECTRICIAN.....	\$ 47.85	24.41

HOURLY ZONE PAY:

Hourly Zone Pay shall be paid on jobs located outside of the free zone computed from the city center of the following listed cities:

Portland, The Dalles, Hood River, Tillamook, Seaside and Astoria

Zone Pay:  
 Zone 1: 31-50 miles \$1.50/hour  
 Zone 2: 51-70 miles \$3.50/hour  
 Zone 3: 71-90 miles \$5.50/hour  
 Zone 4: Beyond 90 miles \$9.00/hour

\*These are not miles driven. Zones are based on Delorme Street Atlas USA 2006 plus.

---

ELEC0048-029 01/01/2020

COWLITZ AND WAHKIAKUM COUNTY

	Rates	Fringes
CABLE SPLICER.....	\$ 44.22	21.50
ELECTRICIAN.....	\$ 47.85	24.41

-----  
 ELEC0073-001 01/01/2020

ADAMS, FERRY, LINCOLN, PEND OREILLE, SPOKANE, STEVENS, WHITMAN  
 COUNTIES

	Rates	Fringes
CABLE SPLICER.....	\$ 34.10	16.68
ELECTRICIAN.....	\$ 36.05	19.23

-----

ELEC0076-002 08/31/2018

GRAYS HARBOR, LEWIS, MASON, PACIFIC, PIERCE, AND THURSTON  
 COUNTIES

	Rates	Fringes
CABLE SPLICER.....	\$ 48.06	23.23
ELECTRICIAN.....	\$ 43.69	23.10

-----

ELEC0112-005 06/01/2019

ASOTIN, BENTON, COLUMBIA, FRANKLIN, GARFIELD, KITTITAS, WALLA  
 WALLA, YAKIMA COUNTIES

	Rates	Fringes
CABLE SPLICER.....	\$ 48.35	21.13
ELECTRICIAN.....	\$ 46.05	21.06

-----

ELEC0191-003 06/01/2020

ISLAND, SAN JUAN, SNOHOMISH, SKAGIT AND WHATCOM COUNTIES

	Rates	Fringes
CABLE SPLICER.....	\$ 44.23	17.73
ELECTRICIAN.....	\$ 47.95	26.16

-----

ELEC0191-004 06/01/2018

CHELAN, DOUGLAS, GRANT AND OKANOGAN COUNTIES

	Rates	Fringes
CABLE SPLICER.....	\$ 40.82	17.63
ELECTRICIAN.....	\$ 42.45	21.34

-----

ENGI0302-003 06/01/2020

CHELAN (WEST OF THE 120TH MERIDIAN), CLALLAM, DOUGLAS (WEST OF THE 120TH MERIDIAN), GRAYS HARBOR, ISLAND, JEFFERSON, KING, KITSAP, KITTITAS, MASON, OKANOGAN (WEST OF THE 120TH MERIDIAN), SAN JUNA, SKAGIT, SNOHOMISH, WHATCOM AND YAKIMA (WEST OF THE 120TH MERIDIAN) COUNTIES

Zone 1 (0-25 radius miles):

	Rates	Fringes
POWER EQUIPMENT OPERATOR		
Group 1A.....	\$ 48.41	22.47
Group 1AA.....	\$ 49.13	22.47
Group 1AAA.....	\$ 49.83	22.47
Group 1.....	\$ 47.70	22.47
Group 2.....	\$ 47.08	22.47
Group 3.....	\$ 46.55	22.47
Group 4.....	\$ 43.54	22.47

Zone Differential (Add to Zone 1 rates):

Zone 2 (26-45 radius miles) - \$1.00

Zone 3 (Over 45 radius miles) - \$1.30

BASEPOINTS: Aberdeen, Bellingham, Bremerton, Everett, Kent, Mount Vernon, Port Angeles, Port Townsend, Seattle, Shelton, Wenatchee, Yakima

#### POWER EQUIPMENT OPERATORS CLASSIFICATIONS

GROUP 1AAA - Cranes-over 300 tons, or 300 ft of boom  
(including jib with attachments)

GROUP 1AA - Cranes 200 to 300 tons, or 250 ft of boom  
(including jib with attachments); Tower crane over 175 ft  
in height, base to boom

GROUP 1A - Cranes, 100 tons thru 199 tons, or 150 ft of boom  
(including jib with attachments); Crane-overhead, bridge  
type, 100 tons and over; Tower crane up to 175 ft in height  
base to boom; Loaders-overhead, 8 yards and over; Shovels,  
excavator, backhoes-6 yards and over with attachments



GROUP 1 - Cableway; Cranes 45 tons thru 99 tons, under 150 ft of boom (including jib with attachments); Crane-overhead, bridge type, 45 tons thru 99 tons; Derricks on building work; Excavator, shovel, backhoes over 3 yards and under 6 yards; Hard tail end dump articulating off-road equipment 45 yards and over; Loader- overhead 6 yards to, but not including 8 yards; Mucking machine, mole, tunnel, drill and/or shield; Quad 9, HD 41, D-10; Remote control operator on rubber tired earth moving equipment; Rollagon; Scrapers-self propelled 45 yards and over; Slipform pavers; Transporters, all truck or track type

GROUP 2 - Barrier machine (zipper); Batch Plant Operaor-Concrete; Bump Cutter; Cranes, 20 tons thru 44 tons with attachments; Crane-overhead, bridge type-20 tons through 44 tons; Chipper; Concrete Pump-truck mount with boom attachment; Crusher; Deck Engineer/Deck Winches (power); Drilling machine; Excavator, shovel, backhoe-3yards and under; Finishing Machine, Bidwell, Gamaco and similar equipment; Guardrail punch; Horizontal/directional drill operator; Loaders-overhead under 6 yards; Loaders-plant feed; Locomotives-all; Mechanics-all; Mixers-asphalt plant; Motor patrol graders-finishing; Piledriver (other than crane mount); Roto-mill, roto-grinder; Screedman, spreader, topside operator-Blaw Knox, Cedar Rapids, Jaeger, Caterpillar, Barbar Green; Scraper-self propelled, hard tail end dump, articulating off-road equipment-under 45 yards; Subgrade trimmer; Tractors, backhoes-over 75 hp; Transfer material service machine-shuttle buggy, blaw knox-roadtec; Truck crane oiler/driver-100 tons and over; Truck Mount portable conveyor; Yo Yo Pay dozer

GROUP 3 - Conveyors; Cranes-thru 19 tons with attachments; A-frame crane over 10 tons; Drill oilers-auger type, truck or crane mount; Dozers-D-9 and under; Forklift-3000 lbs. and over with attachments; Horizontal/directional drill locator; Outside hoists-(elevators and manlifts), air tuggers, strato tower bucket elevators; Hydralifts/boom trucks over 10 tons; Loader-elevating type, belt; Motor patrol grader-nonfinishing; Plant oiler- asphalt, crusher; Pumps-concrete; Roller, plant mix or multi-lift materials; Saws-concrete; Scrpers-concrete and carry-all; Service engineer-equipment; Trenching machines; Truck Crane Oiler/Driver under 100 tons; Tractors, backhoe 75 hp and under

GROUP 4 - Assistant Engineer; Bobcat; Brooms; Compressor; Concrete finish mahine-laser screed; Cranes-A frame-10 tons and under; Elevator and Manlift-permanent or shaft type; Gradechecker, Stakehop; Forklifts under 3000 lbs. with attachments; Hydralifts/boom trucks, 10 tons and under; Oil distributors, blower distribution and mulch seeding operator; Pavement breaker; Posthole digger, mechanical; Power plant; Pumps, water; Rigger and Bellman; Roller-other than plant mix; Wheel Tractors, farmall type; Shotcrete/gunite equipment operator

HANDLING OF HAZARDOUS WASTE MATERIALS:

Personnel in all craft classifications subject to working inside a federally designated hazardous perimeter shall be eligible for compensation in accordance with the following group schedule relative to the level of hazardous waste as outlined in the specific hazardous waste project site safety plan.

H-1 Base wage rate when on a hazardous waste site when not outfitted with protective clothing

H-2 Class "C" Suit - Base wage rate plus \$ .25 per hour.

H-3 Class "B" Suit - Base wage rate plus \$ .50 per hour.

H-4 Class "A" Suit - Base wage rate plus \$ .75 per hour.

-----  
 ENGI0370-002 07/01/2019

ADAMS, ASOTIN, BENTON, CHELAN (EAST OF THE 120TH MERIDIAN), COLUMBIA, DOUGLAS (EAST OF THE 120TH MERIDIAN), FERRY, FRANKLIN, GARFIELD, GRANT, LINCOLN, OKANOGAN (EAST OF THE 120TH MERIDIAN), PEND OREILLE, SPOKANE, STEVENS, WALLA WALLA, WHITMAN AND YAKIMA (EAST OF THE 120TH MERIDIAN) COUNTIES

ZONE 1:

	Rates	Fringes
POWER EQUIPMENT OPERATOR		
GROUP 1.....	\$ 28.46	17.25
GROUP 2.....	\$ 28.78	17.25
GROUP 3.....	\$ 29.39	17.25
GROUP 4.....	\$ 29.55	17.25
GROUP 5.....	\$ 29.71	17.25
GROUP 6.....	\$ 29.99	17.25
GROUP 7.....	\$ 30.26	17.25
GROUP 8.....	\$ 31.36	17.25

ZONE DIFFERENTIAL (Add to Zone 1 rate): Zone 2 - \$2.00

Zone 1: Within 45 mile radius of Spokane, Pasco, Washington; Lewiston, Idaho

Zone 2: Outside 45 mile radius of Spokane, Pasco, Washington; Lewiston, Idaho

## POWER EQUIPMENT OPERATORS CLASSIFICATIONS

GROUP 1: Bit Grinders; Bolt Threading Machine; Compressors (under 2000 CFM, gas, diesel, or electric power); Deck Hand; Fireman & Heater Tender; Hydro-seeder, Mulcher, Nozzleman; Oiler Driver, & Cable Tender, Mucking Machine; Pumpman; Rollers, all types on subgrade, including seal and chip coatings (farm type, Case, John Deere & similar, or Compacting Vibrator), except when pulled by Dozer with operable blade; Welding Machine; Crane Oiler-Driver (CLD required) & Cable Tender, Mucking Machine

GROUP 2: A-frame Truck (single drum); Assistant Refrigeration Plant (under 1000 ton); Assistant Plant Operator, Fireman or Pugmixer (asphalt); Bagley or Stationary Scraper; Belt Finishing Machine; Blower Operator (cement); Cement Hog; Compressor (2000 CFM or over, 2 or more, gas diesel or electric power); Concrete Saw (multiple cut); Distributor Leverman; Ditch Witch or similar; Elevator Hoisting Materials; Dope Pots (power agitated); Fork Lift or Lumber Stacker, hydra-lift & similar; Gin Trucks (pipeline); Hoist, single drum; Loaders (bucket elevators and conveyors); Longitudinal Float; Mixer (portable-concrete); Pavement Breaker, Hydra-Hammer & similar; Power Broom; Railroad Ballast Regulation Operator (self-propelled); Railroad Power Tamper Operator (self-propelled); Railroad Tamper Jack Operator (self-propelled); Spray Curing Machine (concrete); Spreader Box (self-propelled); Straddle Buggy (Ross & similar on construction job only); Tractor (Farm type R/T with attachment, except Backhoe); Tugger Operator

GROUP 3: A-frame Truck (2 or more drums); Assistant Refrigeration Plant & Chiller Operator (over 1000 ton); Backfillers (Cleveland & similar); Batch Plant & Wet Mix Operator, single unit (concrete); Belt-Crete Conveyors with power pack or similar; Belt Loader (Kocal or similar); Bending Machine; Bob Cat (Skid Steer); Boring Machine (earth); Boring Machine (rock under 8 inch bit) (Quarry Master, Joy or similar); Bump Cutter (Wayne, Saginaw or similar); Canal Lining Machine (concrete); Chipper (without crane); Cleaning & Doping Machine (pipeline); Deck Engineer; Elevating Belt-type Loader (Euclid, Barber Green & similar); Elevating Grader-type Loader (Dumor, Adams or similar); Generator Plant Engineers (diesel or electric); Gunnite Combination Mixer & Compressor; Locomotive Engineer; Mixermobile; Mucking Machine; Posthole Auger or Punch; Pump (grout or jet); Soil Stabilizer (P & H or similar); Spreader Machine; Dozer/Tractor (up to D-6 or equivalent) and Traxcavator; Traverse Finish Machine; Turnhead Operator



GROUP 4: Concrete Pumps (squeeze-crete, flow-crete, pump-crete, Whitman & similar); Curb Extruder (asphalt or concrete); Drills (churn, core, calyx or diamond); Equipment Serviceman; Greaser & Oiler; Hoist (2 or more drums or Tower Hoist); Loaders (overhead & front-end, under 4 yds. R/T); Refrigeration Plant Engineer (under 1000 ton); Rubber-tired Skidders (R/T with or without attachments); Surface Heater & Plant Machine; Trenching Machines (under 7 ft. depth capacity); Turnhead (with re-screening); Vacuum Drill (reverse circulation drill under 8 inch bit)

GROUP 5: Backhoe (under 45,000 gw); Backhoe & Hoe Ram (under 3/4 yd.); Carrydeck & Boom Truck (under 25 tons); Cranes (25 tons & under), all attachments including clamshell, dragline; Derricks & Stifflegs (under 65 tons); Drilling Equipment (8 inch bit & over) (Robbins, reverse circulation & similar); Hoe Ram; Piledriving Engineers; Paving (dual drum); Railroad Track Liner Operatoer (self-propelled); Refrigeration Plant Engineer (1000 tons & over); Signalman (Whirleys, Highline Hammerheads or similar); Grade Checker

GROUP 6: Asphalt Plant Operator; Automatic Subgrader (Ditches & Trimmers) (Autograde, ABC, R.A. Hansen & similar on grade wire); Backhoe (45,000 gw and over to 110,000 gw); Backhoes & Hoe Ram (3/4 yd. to 3 yd.); Batch Plant (over 4 units); Batch & Wet Mix Operator (multiple units, 2 & incl. 4); Blade Operator (motor patrol & attachments); Cable Controller (dispatcher); Compactor (self-propelled with blade); Concrete Pump Boom Truck; Concrete Slip Form Paver; Cranes (over 25 tons, to and including 45 tons), all attachments including clamshell, dragline; Crusher, Grizzle & Screening Plant Operator; Dozer, 834 R/T & similar; Drill Doctor; Loader Operator (front-end & overhead, 4 yds. incl. 8 yds.); Multiple Dozer Units with single blade; Paving Machine (asphalt and concrete); Quad-Track or similar equipment; Roller (finishing asphalt pavement); Roto Mill (pavement grinder); Scrapers, all, rubber-tired; Screed Operator; Shovel (under 3 yds.); Trenching Machines (7 ft. depth & over); Tug Boat Operator Vector guzzler, super sucker; Lime Batch Tank Operator (REcycle Train); Lime Brain Operator (Recycle Train); Mobile Crusher Operator (Recycle Train)

GROUP 7: Backhoe (over 110,000 gw); Backhoes & Hoe Ram (3 yds & over); Blade (finish & bluetop) Automatic, CMI, ABC, Finish Athey & Huber & similar when used as automatic; Cableway Operators; Concrete Cleaning/Decontamination machine operator; Cranes (over 45 tons to but not including 85 tons), all attachments including clamshell and dragline; Derricks & Stiffleys (65 tons & over); Elevating Belt (Holland type); Heavy equipment robotics operator; Loader (360 degrees revolving Koehring Scooper or similar); Loaders (overhead & front-end, over 8 yds. to 10 yds.); Rubber-tired Scrapers (multiple engine with three or more scrapers); Shovels (3 yds. & over); Whirleys & Hammerheads, ALL; H.D. Mechanic; H.D. Welder; Hydraulic Platform Trailers (Goldhofer, Shaurerly and Similar); Ultra High Pressure Waterjet Cutting Tool System Operator (30,000 psi); Vacuum Blasting Machine Operator

GROUP 8: Cranes (85 tons and over, and all climbing, overhead, rail and tower), all attachments including clamshell, dragline; Loaders (overhead and front-end, 10 yards and over); Helicopter Pilot

BOOM PAY: (All Cranes, Including Tower)  
 180 ft to 250 ft \$ .50 over scale  
 Over 250 ft \$ .80 over scale

NOTE:

In computing the length of the boom on Tower Cranes, they shall be measured from the base of the Tower to the point of the boom.

HAZMAT:

Anyone working on HAZMAT jobs, working with supplied air shall receive \$1.00 an hour above classification.

-----  
 ENGI0612-001 09/28/2018

PIERCE County

ON PROJECTS DESCRIBED IN FOOTNOTE A BELOW, THE RATE FOR EACH GROUP SHALL BE 90% OF THE BASE RATE PLUS FULL FRINGE BENEFITS. ON ALL OTHER WORK, THE FOLLOWING RATES APPLY.

Zone 1 (0-25 radius miles):

	Rates	Fringes
POWER EQUIPMENT OPERATOR		
GROUP 1A.....	\$ 44.44	19.97
GROUP 1AA.....	\$ 45.09	19.97
GROUP 1AAA.....	\$ 45.73	19.97
GROUP 1.....	\$ 43.79	19.97
GROUP 2.....	\$ 43.23	19.97
GROUP 3.....	\$ 42.74	19.97
GROUP 4.....	\$ 40.01	19.97

Zone Differential (Add to Zone 1 rates):

Zone 2 (26-45 radius miles) = \$1.00

Zone 3 (Over 45 radius miles) - \$1.30

BASEPOINTS: CENTRALIA, OLYMPIA, TACOMA

#### POWER EQUIPMENT OPERATORS CLASSIFICATIONS

GROUP 1 AAA - Cranes-over 300 tons or 300 ft of boom  
(including jib with attachments)

GROUP 1AA - Cranes- 200 tonsto 300 tons, or 250 ft of boom  
(including jib with attachments; Tower crane over 175 ft in  
height, bas to boom

GROUP 1A - Cranes, 100 tons thru 199 tons, or 150 ft of boom  
(including jib with attachments); Crane-overhead, bridge  
type, 100 tons and over; Tower crane up to 175 ft in height  
base to boom; Loaders-overhead, 8 yards and over; Shovels,  
excavator, backhoes-6 yards and over with attachments

GROUP 1 - Cableway; Cranes 45 tons thru 99 tons under 150 ft  
of boom (including jib with attachments); Crane-overhead,  
bridge type, 45 tons thru 99 tons; Derricks on building  
work; Excavator, shovel, backhoes over 3 yards and under 6  
yards; Hard tail end dump articulating off-road equipment  
45 yards and over; Loader- overhead, 6 yards to, but not  
including, 8 yards; Mucking machine, mole, tunnel, drill  
and/or shield; Quad 9 HD 41, D-10; Remote control operator  
on rubber tired earth moving equipment; Rollagon; Scrapers-  
self-propelled 45 yards and over; Slipform pavers;  
Transporters, all track or truck type

GROUP 2 - Barrier machine (zipper); Batch Plant Operator-  
concrete; Bump Cutter; Cranes, 20 tons thru 44 tons with  
attachments; Crane-Overhead, bridge type, 20 tons through  
44 tons; Chipper; Concrete pump-truck mount with boom  
attachment; Crusher; Deck engineer/deck winches (power);  
Drilling machine; Excavator, shovel, backhoe-3 yards and  
under; Finishing machine, Bidwell, Gamaco and similar  
equipment; Guardrail punch; Loaders, overhead under 6  
yards; Loaders-plant feed; Locomotives-all; Mechanics- all;  
Mixers, asphalt plant; Motor patrol graders, finishing;  
Piledriver (other than crane mount); Roto-mill, roto-  
grinder; Screedman, spreader, topside operator-Blaw Knox,  
Cedar Rapids, Jaeger, Caterpillar, Barbar Green;  
Scraper-self- propelled, hard tail end dump, articulating  
off-road equipment- under 45 yards; Subgrader trimmer;  
Tractors, backhoe over 75 hp; Transfer material service  
machine-shuttle buggy, Blaw Knox- Roadtec; Truck Crane  
oiler/driver-100 tons and over; Truck Mount Portable  
Conveyor; Yo Yo pay



GROUP 3 - Conveyors; Cranes through 19 tons with attachments; Crane-A-frame over 10 tons; Drill oilers-auger type, truck or crane mount; Dozer-D-9 and under; Forklift-3000 lbs. and over with attachments; Horizontal/directional drill locator; Outside Hoists-(elevators and manlifts), air tuggers, strato tower bucket elevators; Hydralifts/boom trucks over 10 tons; Loaders-elevating type, belt; Motor patrol grader-nonfinishing; Plant oiler- asphalt, crusher; Pump-Concrete; Roller, plant mix or multi-lfit materials; Saws-concrete; Scrapers, concrete and carry all; Service engineers-equipment; Trenching machines; Truck crane oiler/driver under 100 tons; Tractors, backhoe under 75 hp

GROUP 4 - Assistant Engineer; Bobcat; Brooms; Compressor; Concrete Finish Machine-laser screed; Cranes A-frame 10 tons and under; Elevator and manlift (permanent and shaft type); Forklifts-under 3000 lbs. with attachments; Gradechecker, stakehop; Hydralifts/boom trucks, 10 tons and under; Oil distributors, blower distribution and mulch seeding operator; Pavement breaker; Posthole digger-mechanical; Power plant; Pumps-water; Rigger and Bellman; Roller-other than plant mix; Wheel Tractors, farmall type; Shotcrete/gunite equipment operator

FOOTNOTE A- Reduced rates may be paid on the following:

1. Projects involving work on structures such as buildings and bridges whose total value is less than \$1.5 million excluding mechanical, electrical, and utility portions of the contract.
2. Projects of less than \$1 million where no building is involved. Surfacing and paving included, but utilities excluded.
3. Marine projects (docks, wharfs, etc.) less than \$150,000.

HANDLING OF HAZARDOUS WASTE MATERIALS: Personnel in all craft classifications subject to working inside a federally designated hazardous perimeter shall be eligible for compensation in accordance with the following group schedule relative to the level of hazardous waste as outlined in the specific hazardous waste project site safety plan.

H-1 Base wage rate when on a hazardous waste site when not outfitted with protective clothing, Class "D" Suit - Base wage rate plus \$ .50 per hour.

H-2 Class "C" Suit - Base wage rate plus \$1.00 per hour.

H-3 Class "B" Suit - Base wage rate plus \$1.50 per hour.

H-4 Class "A" Suit - Base wage rate plus \$2.00 per hour.

ENGI0612-012 09/28/2018

LEWIS, PACIFIC (portion lying north of a parallel line extending west from the northern boundary of Wahkaikum County to the sea) AND THURSTON COUNTIES

ON PROJECTS DESCRIBED IN FOOTNOTE A BELOW, THE RATE FOR EACH GROUP SHALL BE 90% OF THE BASE RATE PLUS FULL FRINGE BENEFITS. ON ALL OTHER WORK, THE FOLLOWING RATES APPLY.

Zone 1 (0-25 radius miles):

	Rates	Fringes
POWER EQUIPMENT OPERATOR		
GROUP 1A.....	\$ 44.44	19.97
GROUP 1AA.....	\$ 45.09	19.97
GROUP 1AAA.....	\$ 45.73	19.97
GROUP 1.....	\$ 43.79	19.97
GROUP 2.....	\$ 43.23	19.97
GROUP 3.....	\$ 42.74	19.97
GROUP 4.....	\$ 40.01	19.97

Zone Differential (Add to Zone 1 rates):

Zone 2 (26-45 radius miles) = \$1.00

Zone 3 (Over 45 radius miles) - \$1.30

BASEPOINTS: CENTRALIA, OLYMPIA, TACOMA

POWER EQUIPMENT OPERATORS CLASSIFICATIONS

GROUP 1 AAA - Cranes-over 300 tons or 300 ft of boom (including jib with attachments)

GROUP 1AA - Cranes- 200 tonsto 300 tons, or 250 ft of boom (including jib with attachments; Tower crane over 175 ft in height, bas to boom

GROUP 1A - Cranes, 100 tons thru 199 tons, or 150 ft of boom (including jib with attachments); Crane-overhead, bridge type, 100 tons and over; Tower crane up to 175 ft in height base to boom; Loaders-overhead, 8 yards and over; Shovels, excavator, backhoes-6 yards and over with attachments

GROUP 1 - Cableway; Cranes 45 tons thru 99 tons under 150 ft of boom (including jib with attachments); Crane-overhead, bridge type, 45 tons thru 99 tons; Derricks on building work; Excavator, shovel, backhoes over 3 yards and under 6 yards; Hard tail end dump articulating off-road equipment 45 yards and over; Loader- overhead, 6 yards to, but not including, 8 yards; Mucking machine, mole, tunnel, drill and/or shield; Quad 9 HD 41, D-10; Remote control operator on rubber tired earth moving equipment; Rollagon; Scrapers-self-propelled 45 yards and over; Slipform pavers; Transporters, all track or truck type

GROUP 2 - Barrier machine (zipper); Batch Plant Operator-concrete; Bump Cutter; Cranes, 20 tons thru 44 tons with attachments; Crane-Overhead, bridge type, 20 tons through 44 tons; Chipper; Concrete pump-truck mount with boom attachment; Crusher; Deck engineer/deck winches (power); Drilling machine; Excavator, shovel, backhoe-3 yards and under; Finishing machine, Bidwell, Gamaco and similar equipment; Guardrail punch; Loaders, overhead under 6 yards; Loaders-plant feed; Locomotives-all; Mechanics- all; Mixers, asphalt plant; Motor patrol graders, finishing; Piledriver (other than crane mount); Roto-mill, roto-grinder; Screedman, spreader, topside operator-Blaw Knox, Cedar Rapids, Jaeger, Caterpillar, Barbar Green; Scraper-self-propelled, hard tail end dump, articulating off-road equipment- under 45 yards; Subgrader trimmer; Tractors, backhoe over 75 hp; Transfer material service machine-shuttle buggy, Blaw Knox- Roadtec; Truck Crane oiler/driver-100 tons and over; Truck Mount Portable Conveyor; Yo Yo pay

GROUP 3 - Conveyors; Cranes through 19 tons with attachments; Crane-A-frame over 10 tons; Drill oilers-auger type, truck or crane mount; Dozer-D-9 and under; Forklift-3000 lbs. and over with attachments; Horizontal/directional drill locator; Outside Hoists-(elevators and manlifts), air tuggers, strato tower bucket elevators; Hydralifts/boom trucks over 10 tons; Loaders-elevating type, belt; Motor patrol grader-nonfinishing; Plant oiler- asphalt, crusher; Pump-Concrete; Roller, plant mix or multi-lfit materials; Saws-concrete; Scrapers, concrete and carry all; Service engineers-equipment; Trenching machines; Truck crane oiler/driver under 100 tons; Tractors, backhoe under 75 hp

GROUP 4 - Assistant Engineer; Bobcat; Brooms; Compressor; Concrete Finish Machine-laser screed; Cranes A-frame 10 tons and under; Elevator and manlift (permanent and shaft type); Forklifts-under 3000 lbs. with attachments; Gradechecker, stakehop; Hydralifts/boom trucks, 10 tons and under; Oil distributors, blower distribution and mulch seeding operator; Pavement breaker; Posthole digger-mechanical; Power plant; Pumps-water; Rigger and Bellman; Roller-other than plant mix; Wheel Tractors, farmall type; Shotcrete/gunite equipment operator

FOOTNOTE A- Reduced rates may be paid on the following:

1. Projects involving work on structures such as buildings and bridges whose total value is less than \$1.5 million excluding mechanical, electrical, and utility portions of the contract.
2. Projects of less than \$1 million where no building is involved. Surfacing and paving included, but utilities excluded.
3. Marine projects (docks, wharfs, etc.) less than \$150,000.

HANDLING OF HAZARDOUS WASTE MATERIALS: Personnel in all craft classifications subject to working inside a federally designated hazardous perimeter shall be eligible for compensation in accordance with the following group schedule relative to the level of hazardous waste as outlined in the specific hazardous waste project site safety plan.

H-1 Base wage rate when on a hazardous waste site when not outfitted with protective clothing, Class "D" Suit - Base wage rate plus \$ .50 per hour.

H-2 Class "C" Suit - Base wage rate plus \$1.00 per hour.

H-3 Class "B" Suit - Base wage rate plus \$1.50 per hour.

H-4 Class "A" Suit - Base wage rate plus \$2.00 per hour.

-----  
 ENGI0701-002 01/01/2018

CLARK, COWLITZ, KLICKITAT, PACIFIC (SOUTH), SKAMANIA, AND WAHKIAKUM COUNTIES

POWER EQUIPMENT OPERATORS: ZONE 1

	Rates	Fringes
POWER EQUIPMENT OPERATOR		
GROUP 1.....	\$ 41.65	14.35
GROUP 1A.....	\$ 43.73	14.35
GROUP 1B.....	\$ 45.82	14.35
GROUP 2.....	\$ 39.74	14.35
GROUP 3.....	\$ 38.59	14.35
GROUP 4.....	\$ 37.51	14.35
GROUP 5.....	\$ 36.27	14.35
GROUP 6.....	\$ 33.05	14.35

Zone Differential (add to Zone 1 rates):

Zone 2 - \$3.00

Zone 3 - \$6.00

For the following metropolitan counties: MULTNOMAH; CLACKAMAS; MARION; WASHINGTON; YAMHILL; AND COLUMBIA; CLARK; AND COWLITZ COUNTY, WASHINGTON WITH MODIFICATIONS AS INDICATED:

All jobs or projects located in Multnomah, Clackamas and Marion Counties, West of the western boundary of Mt. Hood National Forest and West of Mile Post 30 on Interstate 84 and West of Mile Post 30 on State Highway 26 and West of Mile Post 30 on Highway 22 and all jobs or projects located in Yamhill County, Washington County and Columbia County and all jobs or projects located in Clark & Cowlitz County, Washington except that portion of Cowlitz County in the Mt. St. Helens "Blast Zone" shall receive Zone I pay for all classifications.



All jobs or projects located in the area outside the identified boundary above, but less than 50 miles from the Portland City Hall shall receive Zone II pay for all classifications.

All jobs or projects located more than 50 miles from the Portland City Hall, but outside the identified border above, shall receive Zone III pay for all classifications.

For the following cities: ALBANY; BEND; COOS BAY; EUGENE; GRANTS PASS; KLAMATH FALLS; MEDFORD; ROSEBURG

All jobs or projects located within 30 miles of the respective city hall of the above mentioned cities shall receive Zone I pay for all classifications.

All jobs or projects located more than 30 miles and less than 50 miles from the respective city hall of the above mentioned cities shall receive Zone II pay for all classifications.

All jobs or projects located more than 50 miles from the respective city hall of the above mentioned cities shall receive Zone III pay for all classifications.

#### POWER EQUIPMENT OPERATORS CLASSIFICATIONS

##### Group 1

Concrete Batch Plan and or Wet mix three (3) units or more; Crane, Floating one hundred and fifty (150) ton but less than two hundred and fifty (250) ton; Crane, two hundred (200) ton through two hundred ninety nine (299) ton with two hundred foot (200') boom or less (including jib, inserts and/or attachments); Crane, ninety (90) ton through one hundred ninety nine (199) ton with over two hundred (200') boom Including jib, inserts and/or attachments); Crane, Tower Crane with one hundred seventy five foot (175') tower or less and with less than two hundred foot (200') jib; Crane, Whirley ninety (90) ton and over; Helicopter when used in erecting work

##### Group 1A

Crane, floating two hundred fifty (250) ton and over; Crane, two hundred (200) ton through two hundred ninety nine (299) ton, with over two hundred foot (200') boom (including jib, inserts and/or attachments); Crane, three hundred (300) ton through three hundred ninety nine (399) ton; Crane, Tower Crane with over one hundred seventy five foot (175') tower or over two hundred foot (200') jib; Crane, tower Crane on rail system or 2nd tower or more in work radius

## Group 1B

Crane, three hundred (300) ton through three hundred ninety nine (399) ton, with over two hundred foot (200') boom (including jib, inserts and/or attachments); Floating crane, three hundred fifty (350) ton and over; Crane, four hundred (400) ton and over

## Group 2

Asphalt Plant (any type); Asphalt Roto-Mill, pavement profiler eight foot (8') lateral cut and over; Auto Grader or "Trimmer"; Blade, Robotic; Bulldozer, Robotic Equipment (any type); Bulldozer, over one hundred twenty thousand (120,000) lbs. and above; Concrete Batch Plant and/or Wet Mix one (1) and two (2) drum; Concrete Diamond Head Profiler; Canal Trimmer; Concrete, Automatic Slip Form Paver (Assistant to the Operator required); Crane, Boom Truck fifty (50) ton and with over one hundred fifty foot (150') boom and over; Crane, Floating (derrick barge) thirty (30) ton but less than one hundred fifty (150) ton; Crane, Cableway twenty-five (25) ton and over; Crane, Floating Clamshell three (3) cu. Yds. And over; Crane, ninety (90) ton through one hundred ninety nine (199) ton up to and including two hundred foot (200') of boom (including jib inserts and/or attachments); Crane, fifty (50) ton through eighty nine (89) ton with over one hundred fifty foot (150') boom (including jib inserts and/or attachments); Crane, Whirley under ninety (90) ton; Crusher Plant; Excavator over one hundred thirty thousand (130,000) lbs.; Loader one hundred twenty thousand (120,000) lbs. and above; Remote Controlled Earth Moving Equipment; Shovel, Dragline, Clamshell, five (5) cu. Yds. And over; Underwater Equipment remote or otherwise, when used in construction work; Wheel Excavator any size

## Group 3

Bulldozer, over seventy thousand (70,000) lbs. up to and including one hundred twenty thousand (120,000) lbs.; Crane, Boom Truck fifty (50) ton and over with less than one hundred fifty foot (150') boom; Crane, fifty (50) ton through eighty nine (89) ton with one hundred fifty foot (150') boom or less (including jib inserts and/or attachments); Crane, Shovel, Dragline or Clamshell three (3) cu. yds. but less than five (5) cu. Yds.; Excavator over eighty thousand (80,000) lbs. through one hundred thirty thousand (130,000) lbs.; Loader sixty thousand (60,000) lbs. and less than one hundred twenty thousand (120,000) lbs.

## Group 4

Asphalt, Screed; Asphalt Paver; Asphalt Roto-Mill, pavement profiler, under eight foot (8') lateral cut; Asphalt, Material Transfer Vehicle Operator; Back Filling Machine; Backhoe, Robotic, track and wheel type up to and including twenty thousand (20,000) lbs. with any attachments; Blade (any type); Boatman; Boring Machine; Bulldozer over twenty thousand (20,000) lbs. and more than one hundred (100) horse up to seventy thousand (70,000) lbs.; Cable-Plow (any type); Cableway up to twenty five (25) ton; Cat Drill (John Henry); Chippers; Compactor, multi-engine; Compactor, Robotic; Compactor with blade self-propelled; Concrete, Breaker; Concrete, Grout Plant; Concrete, Mixer Mobile; Concrete, Paving Road Mixer; Concrete, Reinforced Tank Banding Machine; Crane, Boom Truck twenty (20) ton and under fifty (50) ton; Crane, Bridge Locomotive, Gantry and Overhead; Crane, Carry Deck; Crane, Chicago Boom and similar types; Crane, Derrick Operator, under one hundred (100) ton; Crane, Floating Clamshell, Dragline, etc. Operator, under three (3) cu. yds. Or less than thirty (30) ton; Crane, under fifty (50) ton; Crane, Quick Tower under one hundred foot (100') in height and less than one hundred fifty foot (150') jib (on rail included); Diesel-Electric Engineer (Plant or Floating); Directional Drill over twenty thousand (20,000) lbs. pullback; Drill Cat Operator; Drill Doctor and/or Bit Grinder; Driller, Percussion, Diamond, Core, Cable, Rotary and similar type; Excavator Operator over twenty thousand (20,000) lbs. through eighty thousand (80,000) lbs.; Generator Operator; Grade-all; Guardrail Machines, i.e. punch, auger, etc.; Hammer Operator (Piledriver); Hoist, stiff leg, guy derrick or similar type, fifty (50) ton and over; Hoist, two (2) drums or more; Hydro Axe (loader mounted or similar type); Jack Operator, Elevating Barges, Barge Operator, self-unloading; Loader Operator, front end and overhead, twenty five thousand (25,000) lbs. and less than sixty thousand (60,000) lbs.; Log Skidders; Piledriver Operator (not crane type); Pipe, Bending, Cleaning, Doping and Wrapping Machines; Rail, Ballast Tamper Multi-Purpose; Rubber-tired Dozers and Pushers; Scraper, all types; Side-Boom; Skip Loader, Drag Box; Strump Grinder (loader mounted or similar type); Surface Heater and Planer; Tractor, rubber-tired, over fifty (50) HP Flywheel; Trenching Machine three foot (3') depth and deeper; Tub Grinder (used for wood debris); Tunnel Boring Machine Mechanic; Tunnel, Mucking Machine; Ultra High Pressure Water Jet Cutting Tool System Operator; Vacuum Blasting Machine Operator; Water pulls, Water wagons

## Group 5

Asphalt, Extrusion Machine; Asphalt, Roller (any asphalt mix); Asphalt, Roto-Mill pavement profiler ground man; Bulldozer, twenty thousand (20,000) lbs. or less, or one hundred (100) horse or less; Cement Pump; Chip Spreading Machine; Churn Drill and Earth Boring Machine; Compactor, self-propelled without blade; Compressor, (any power) one thousand two hundred fifty (1,250) cu. ft. and over, total capacity; Concrete, Batch Plant Quality control; Concrete, Combination Mixer and compressor operator, gunite work; Concrete, Curb Machine, Mechanical Berm, Curb and/or Curb and Gutter; Concrete, Finishing Machine; Concrete, Grouting Machine; Concrete, Internal Full Slab Vibrator Operator; Concrete, Joint Machine; Concrete, Mixer single drum, any capacity; Concrete, Paving Machine eight foot (8') or less; Concrete, Planer; Concrete, Pump; Concrete, Pump Truck; Concrete, Pumpcrete Operator (any type); Concrete, Slip Form Pumps, power driven hydraulic lifting device for concrete forms; Conveyored Material Hauler; Crane, Boom Truck under twenty (20) tons; Crane, Boom Type lifting device, five (5) ton capacity or less; Drill, Directional type less than twenty thousand (20,000) lbs. pullback; Fork Lift, over ten (10) ton or Robotic; Helicopter Hoist; Hoist Operator, single drum; Hydraulic Backhoe track type up to and including twenty thousand (20,000) lbs.; Hydraulic Backhoe wheel type (any make); Laser Screed; Loaders, rubber-tired type, less than twenty five thousand (25,000) lbs.; Pavement Grinder and/or Grooving Machine (riding type); Pipe, cast in place Pipe Laying Machine; Pulva-Mixer or similar types; Pump Operator, more than five (5) pumps (any size); Rail, Ballast Compactor, Regulator, or Tamper machines; Service Oiler (Greaser); Sweeper Self-Propelled; Tractor, Rubber-Tired, fifty (50) HP flywheel and under; Trenching Machine Operator, maximum digging capacity three foot (3') depth; Tunnel, Locomotive, Dinkey; Tunnel, Power Jumbo setting slip forms, etc.

## Group 6

Asphalt, Pugmill (any type); Asphalt, Raker; Asphalt, Truck Mounted Asphalt Spreader, with Screed; Auger Oiler; Boatman; Bobcat, skid steer (less than one (1) yard); Broom, self-propelled; Compressor Operator (any power) under 1,250 cu. ft. total capacity; Concrete Curing Machine (riding type); Concrete Saw; Conveyor Operator or Assistant; Crane, Tugger; Crusher Feeder; Crusher Oiler; Deckhand; Drill, Directional Locator; Fork Lift; Grade Checker; Guardrail Punch Oiler; Hydrographic Seeder Machine, straw, pulp or seed; Hydrostatic Pump Operator; Mixer Box (CTB, dry batch, etc.); Oiler; Plant Oiler; Pump (any power); Rail, Brakeman, Switchman, Motorman; Rail, Tamping Machine, mechanical, self-propelled; Rigger; Roller grading (not asphalt); Truck, Crane Oiler-Driver



IRON0014-005 07/01/2019

ADAMS, ASOTIN, BENTON, COLUMBIA, DOUGLAS, FERRY, FRANKLIN,  
GARFIELD, GRANT, LINCOLN, OKANOGAN, PEND ORIELLE, SPOKANE,  
STEVENS, WALLA WALLA AND WHITMAN COUNTIES

	Rates	Fringes
IRONWORKER.....	\$ 33.59	29.26

---

IRON0029-002 05/01/2018

CLARK, COWLITZ, KLICKITAT, PACIFIC, SKAMANIA, AND WAHKAIKUM  
COUNTIES

	Rates	Fringes
IRONWORKER.....	\$ 37.00	27.87

---

IRON0086-002 07/01/2019

YAKIMA, KITTITAS AND CHELAN COUNTIES

	Rates	Fringes
IRONWORKER.....	\$ 33.59	29.26

---

IRON0086-004 07/01/2019

CLALLAM, GRAYS HARBOR, ISLAND, JEFFERSON, KING, KITSAP, LEWIS,  
MASON, PIERCE, SKAGIT, SNOHOMISH, THURSTON, AND WHATCOM COUNTIES

	Rates	Fringes
IRONWORKER.....	\$ 42.35	29.56

---

LABO0238-004 06/01/2020

PASCO AREA: ADAMS, BENTON, COLUMBIA, DOUGLAS (East of 120th Meridian), FERRY, FRANKLIN, GRANT, OKANOGAN, WALLA WALLA

SPOKANE AREA: ASOTIN, GARFIELD, LINCOLN, PEND OREILLE, SPOKANE, STEVENS & WHITMAN COUNTIES

	Rates	Fringes
LABORER (PASCO)		
GROUP 1.....	\$ 26.69	13.65
GROUP 2.....	\$ 28.79	13.65
GROUP 3.....	\$ 29.06	13.65
GROUP 4.....	\$ 29.33	13.65
GROUP 5.....	\$ 29.61	13.65
LABORER (SPOKANE)		
GROUP 1.....	\$ 26.69	13.65
GROUP 2.....	\$ 28.79	13.65
GROUP 3.....	\$ 29.06	13.65
GROUP 4.....	\$ 29.33	13.65
GROUP 5.....	\$ 29.61	13.65

Zone Differential (Add to Zone 1 rate): \$2.00

BASE POINTS: Spokane, Pasco, Lewiston

Zone 1: 0-45 radius miles from the main post office.

Zone 2: 45 radius miles and over from the main post office.

LABORERS CLASSIFICATIONS

GROUP 1: Flagman; Landscape Laborer; Scaleman; Traffic Control Maintenance Laborer (to include erection and maintenance of barricades, signs and relief of flagperson); Window Washer/Cleaner (detail cleanup, such as, but not limited to cleaning floors, ceilings, walls, windows, etc. prior to final acceptance by the owner)

GROUP 2: Asbestos Abatement Worker; Brush Hog Feeder; Carpenter Tender; Cement Handler; Clean-up Laborer; Concrete Crewman (to include stripping of forms, hand operating jacks on slip form construction, application of concrete curing compounds, pumpcrete machine, signaling, handling the nozzle of squeezecrete or similar machine, 6 inches and smaller); Confined Space Attendant; Concrete Signalman; Crusher Feeder; Demolition (to include clean-up, burning, loading, wrecking and salvage of all material); Dumpman; Fence Erector; Firewatch; Form Cleaning Machine Feeder; Stacker; General Laborer; Grout Machine Header Tender; Guard Rail (to include guard rails, guide and reference posts, sign posts, and right-of-way markers); Hazardous Waste Worker, Level D (no respirator is used and skin protection is minimal); Miner, Class "A" (to include

all bull gang, concrete crewman, dumpman and pumpcrete crewman, including distributing pipe, assembly & dismantle, and nipper); Nipper; Riprap Man; Sandblast Tailhoseman; Scaffold Erector (wood or steel); Stake Jumper; Structural Mover (to include separating foundation, preparation, cribbing, shoring, jacking and unloading of structures); Tailhoseman (water nozzle); Timber Bucker and Faller (by hand); Track Laborer (RR); Truck Loader; Well-Point Man; All Other Work Classifications Not Specially Listed Shall Be Classified As General Laborer

GROUP 3: Asphalt Roller, walking; Cement Finisher Tender; Concrete Saw, walking; Demolition Torch; Dope Pot Firemen, non-mechanical; Driller Tender (when required to move and position machine); Form Setter, Paving; Grade Checker using level; Hazardous Waste Worker, Level C (uses a chemical "splash suit" and air purifying respirator); Jackhammer Operator; Miner, Class "B" (to include brakeman, finisher, vibrator, form setter); Nozzleman (to include squeeze and flo-crete nozzle); Nozzleman, water, air or steam; Pavement Breaker (under 90 lbs.); Pipelayer, corrugated metal culvert; Pipelayer, multi-plate; Pot Tender; Power Buggy Operator; Power Tool Operator, gas, electric, pneumatic; Railroad Equipment, power driven, except dual mobile power spiker or puller; Railroad Power Spiker or Puller, dual mobile; Rodder and Spreader; Tamper (to include operation of Barco, Essex and similar tampers); Trencher, Shawnee; Tugger Operator; Wagon Drills; Water Pipe Liner; Wheelbarrow (power driven)

GROUP 4: Air and Hydraulic Track Drill; Asphalt Raker; Brush Machine (to include horizontal construction joint cleanup brush machine, power propelled); Caisson Worker, free air; Chain Saw Operator and Faller; Concrete Stack (to include laborers when laborers working on free standing concrete stacks for smoke or fume control above 40 feet high); Guniting (to include operation of machine and nozzle); Hazardous Waste Worker, Level B (uses same respirator protection as Level A. A supplied air line is provided in conjunction with a chemical "splash suit"); High Scaler; Laser Beam Operator (to include grade checker and elevation control); Miner, Class C (to include miner, nozzleman for concrete, laser beam operator and rigger on tunnels); Monitor Operator (air track or similar mounting); Mortar Mixer; Nozzleman (to include jet blasting nozzleman, over 1,200 lbs., jet blast machine power propelled, sandblast nozzle); Pavement Breaker (90 lbs. and over); Pipelayer (to include working topman, caulker, collarman, jointer, mortarman, rigger, jacker, shorer, valve or meter installer); Pipewrapper; Plasterer Tender; Vibrators (all)

GROUP 5 - Drills with Dual Masts; Hazardous Waste Worker, Level A (utilizes a fully encapsulated suit with a self-contained breathing apparatus or a supplied air line); Miner Class "D", (to include raise and shaft miner, laser beam operator on riases and shafts)

LABO0238-006 06/01/2019

COUNTIES EAST OF THE 120TH MERIDIAN: ADAMS, ASOTIN, BENTON, CHELAN, COLUMBIA, DOUGLAS, FERRY, FRANKLIN, GARFIELD, GRANT, LINCOLN, OKANOGAN, PEND OREILLE, STEVENS, SPOKANE, WALLA WALLA, WHITMAN

	Rates	Fringes
Hod Carrier.....	\$ 27.95	12.90

LABO0242-003 06/01/2020

KING COUNTY

	Rates	Fringes
LABORER		
GROUP 1.....	\$ 27.78	12.35
GROUP 2A.....	\$ 31.82	12.35
GROUP 3.....	\$ 39.81	12.35
GROUP 4.....	\$ 40.77	12.35
GROUP 5.....	\$ 41.43	12.35
Group 6.....	\$ 41.43	12.35

BASE POINTS: BELLINGHAM, MT. VERNON, EVERETT, SEATTLE, KENT, TACOMA, OLYMPIA, CENTRALIA, ABERDEEN, SHELTON, PT. TOWNSEND, PT. ANGELES, AND BREMERTON

- ZONE 1 - Projects within 25 radius miles of the respective city hall
- ZONE 2 - More than 25 but less than 45 radius miles from the respective city hall
- ZONE 3 - More than 45 radius miles from the respective city hall

ZONE DIFFERENTIAL (ADD TO ZONE 1 RATES):  
 ZONE 2 - \$1.00  
 ZONE 3 - \$1.30

BASE POINTS: CHELAN, SUNNYSIDE, WENATCHEE, AND YAKIMA

- ZONE 1 - Projects within 25 radius miles of the respective city hall
- ZONE 2 - More than 25 radius miles from the respective city hall

ZONE DIFFERENTIAL (ADD TO ZONE 1 RATES):  
 ZONE 2 - \$2.25



## LABORERS CLASSIFICATIONS

GROUP 1: Landscaping and Planting; Watchman; Window Washer/Cleaner (detail clean-up, such as but not limited to cleaning floors, ceilings, walls, windows, etc., prior to final acceptance by the owner)

GROUP 2A: Batch Weighman; Crusher Feeder; Fence Laborer; Flagman; Pilot Car

GROUP 3: General Laborer; Air, Gas, or Electric Vibrating Screed; Asbestos Abatement Laborer; Ballast Regulator Machine; Brush Cutter; Brush Hog Feeder; Burner; Carpenter Tender; Cement Finisher Tender; Change House or Dry Shack; Chipping Gun (under 30 lbs.); Choker Setter; Chuck Tender; Clean-up Laborer; Concrete Form Stripper; Curing Laborer; Demolition (wrecking and moving including charred material); Ditch Digger; Dump Person; Fine Graders; Firewatch; Form Setter; Gabian Basket Builders; Grout Machine Tender; Grinders; Guardrail Erector; Hazardous Waste Worker (Level C: uses a chemical "splash suit" and air purifying respirator); Maintenance Person; Material Yard Person; Pot Tender; Rip Rap Person; Riggers; Scale Person; Sloper Sprayer; Signal Person; Stock Piler; Stake Hopper; Toolroom Man (at job site); Topper-Tailer; Track Laborer; Truck Spotter; Vinyl Seamer

GROUP 4: Cement Dumper-Paving; Chipping Gun (over 30 lbs.); Clary Power Spreader; Concrete Dumper/Chute Operator; Concrete Saw Operator; Drill Operator (hydraulic, diamond, aiartrac); Faller and Bucker Chain Saw; Grade Checker and Transit Person; Groutmen (pressure) including post tension beams; Hazardous Waste Worker (Level B: uses same respirator protection as Level A. A supplied air line is provided in conjunction with a chemical "splash suit"); High Scaler; Jackhammer; Laserbeam Operator; Manhole Builder-Mudman; Nozzleman (concrete pump, green cutter when using combination of high pressure air and water on concrete and rock, sandblast, gunite, shotcrete, water blaster, vacuum blaster); Pavement Breaker; Pipe Layer and Caulker; Pipe Pot Tender; Pipe Reliner (not insert type); Pipe Wrapper; Power Jacks; Railroad Spike Puller-Power; Raker-Asphalt; Rivet Buster; Rodder; Sloper (over 20 ft); Spreader (concrete); Tamper and Similar electric, air and glas operated tool; Timber Person-sewer (lagger shorer and cribber); Track Liner Power; Tugger Operator; Vibrator; Well Point Laborer

GROUP 5: Caisson Worker; Mortarman and Hodcarrier; Powderman; Re-Timberman; Hazardous Waste Worker (Level A: utilizes a fully encapsulated suit with a self-contained breathing apparatus or a supplied air line).

Group 6: Miner

LABO0252-010 06/01/2020

CLALLAM, GRAYS HARBOR, JEFFERSON, KITSAP, LEWIS, MASON, PACIFIC  
(EXCLUDING SOUTHWEST), PIERCE, AND THURSTON COUNTIES

	Rates	Fringes
LABORER		
GROUP 1.....	\$ 27.78	12.44
GROUP 2.....	\$ 31.82	12.44
GROUP 3.....	\$ 39.81	12.44
GROUP 4.....	\$ 40.77	12.44
GROUP 5.....	\$ 41.43	12.44

BASE POINTS: BELLINGHAM, MT. VERNON, EVERETT, SEATTLE, KENT,  
TACOMA, OLYMPIA, CENTRALIA, ABERDEEN, SHELTON, PT.  
TOWNSEND, PT. ANGELES, AND BREMERTON

ZONE 1 - Projects within 25 radius miles of the respective  
city hall  
 ZONE 2 - More than 25 but less than 45 radius miles from the  
respective city hall  
 ZONE 3 - More than 45 radius miles from the respective city  
hall

ZONE DIFFERENTIAL (ADD TO ZONE 1 RATES):  
 ZONE 2 - \$1.00  
 ZONE 3 - \$1.30

BASE POINTS: CHELAN, SUNNYSIDE, WENATCHEE, AND YAKIMA

ZONE 1 - Projects within 25 radius miles of the respective  
city hall  
 ZONE 2 - More than 25 radius miles from the respective city  
hall

ZONE DIFFERENTIAL (ADD TO ZONE 1 RATES):  
 ZONE 2 - \$2.25

LABORERS CLASSIFICATIONS

GROUP 1: Landscaping and Planting; Watchman; Window  
Washer/Cleaner (detail clean-up, such as but not limited to  
cleaning floors, ceilings, walls, windows, etc., prior to  
final acceptance by the owner)

GROUP 2: Batch Weighman; Crusher Feeder; Fence Laborer;  
Flagman; Pilot Car

GROUP 3: General Laborer; Air, Gas, or Electric Vibrating Screed; Asbestos Abatement Laborer; Ballast Regulator Machine; Brush Cutter; Brush Hog Feeder; Burner; Carpenter Tender; Cement Finisher Tender; Change House or Dry Shack; Chipping Gun (under 30 lbs.); Choker Setter; Chuck Tender; Clean-up Laborer; Concrete Form Stripper; Curing Laborer; Demolition (wrecking and moving including charred material); Ditch Digger; Dump Person; Fine Graders; Firewatch; Form Setter; Gabian Basket Builders; Grout Machine Tender; Grinders; Guardrail Erector; Hazardous Waste Worker (Level C: uses a chemical "splash suit" and air purifying respirator); Maintenance Person; Material Yard Person; Pot Tender; Rip Rap Person; Riggers; Scale Person; Sloper Sprayer; Signal Person; Stock Piler; Stake Hopper; Toolroom Man (at job site); Topper-Tailer; Track Laborer; Truck Spotter; Vinyl Seamer

GROUP 4: Cement Dumper-Paving; Chipping Gun (over 30 lbs.); Clary Power Spreader; Concrete Dumper/Chute Operator; Concrete Saw Operator; Drill Operator (hydraulic, diamond, aiartrac); Faller and Bucker Chain Saw; Groutmen (pressure) including post tension beams; Hazardous Waste Worker (Level B: uses same respirator protection as Level A. A supplied air line is provided in conjunction with a chemical "splash suit"); Jackhammer; Laserbeam Operator; Manhole Builder-Mudman; Nozzleman (concrete pump, green cutter when using combination of high pressure air and water on concrete and rock, sandblast, gunite, shotcrete, water blaster, vacuum blaster); Pavement Breaker; Pipe Layer and Caulker; Pipe Pot Tender; Pipe Reliner (not insert type); Pipe Wrapper; Power Jacks; Railroad Spike Puller-Power; Raker-Asphalt; Rivet Buster; Rodder; Sloper (over 20 ft); Spreader (concrete); Tamper and Similar electric, air and glas operated tool; Timber Person-sewer (lagger shorer and cribber); Track Liner Power; Tugger Operator; Vibrator; Well Point Laborer

GROUP 5: Caisson Worker; Miner; Mortarman and Hodcarrier; Grade Checker and Transit Person; High Scaler; Powderman; Re-Timberman; Hazardous Waste Worker (Level A: utilizes a fully encapsulated suit with a self-contained breathing apparatus or a supplied airline).

LABO0292-008 06/01/2020

ISLAND, SAN JUAN, SKAGIT, SNOHOMISH, AND WHATCOM COUNTIES

	Rates	Fringes
LABORER		
GROUP 1.....	\$ 27.78	12.44
GROUP 2.....	\$ 31.82	12.44
GROUP 3.....	\$ 39.81	12.44
GROUP 4.....	\$ 40.77	12.44
GROUP 5.....	\$ 41.43	12.44

BASE POINTS: BELLINGHAM, MT. VERNON, EVERETT, SEATTLE, KENT,  
TACOMA, OLYMPIA, CENTRALIA, ABERDEEN, SHELTON, PT.  
TOWNSEND, PT. ANGELES, AND BREMERTON

ZONE 1 - Projects within 25 radius miles of the respective  
city hall

ZONE 2 - More than 25 but less than 45 radius miles from the  
respective city hall

ZONE 3 - More than 45 radius miles from the respective city  
hall

ZONE DIFFERENTIAL (ADD TO ZONE 1 RATES):

ZONE 2 - \$1.00

ZONE 3 - \$1.30

BASE POINTS: CHELAN, SUNNYSIDE, WENATCHEE, AND YAKIMA

ZONE 1 - Projects within 25 radius miles of the respective  
city hall

ZONE 2 - More than 25 radius miles from the respective city  
hall

ZONE DIFFERENTIAL (ADD TO ZONE 1 RATES):

ZONE 2 - \$2.25

LABORERS CLASSIFICATIONS

GROUP 1: Landscaping and Planting; Watchman; Window  
Washer/Cleaner (detail clean-up, such as but not limited to  
cleaning floors, ceilings, walls, windows, etc., prior to  
final acceptance by the owner)

GROUP 2: Batch Weighman; Crusher Feeder; Fence Laborer;  
Flagman; Pilot Car

GROUP 3: General Laborer; Air, Gas, or Electric Vibrating Screed; Asbestos Abatement Laborer; Ballast Regulator Machine; Brush Cutter; Brush Hog Feeder; Burner; Carpenter Tender; Cement Finisher Tender; Change House or Dry Shack; Chipping Gun (under 30 lbs.); Choker Setter; Chuck Tender; Clean-up Laborer; Concrete Form Stripper; Curing Laborer; Demolition (wrecking and moving including charred material); Ditch Digger; Dump Person; Fine Graders; Firewatch; Form Setter; Gabian Basket Builders; Grout Machine Tender; Grinders; Guardrail Erector; Hazardous Waste Worker (Level C: uses a chemical "splash suit" and air purifying respirator); Maintenance Person; Material Yard Person; Pot Tender; Rip Rap Person; Riggers; Scale Person; Sloper Sprayer; Signal Person; Stock Piler; Stake Hopper; Toolroom Man (at job site); Topper-Tailer; Track Laborer; Truck Spotter; Vinyl Seamer

GROUP 4: Cement Dumper-Paving; Chipping Gun (over 30 lbs.); Clary Power Spreader; Concrete Dumper/Chute Operator; Concrete Saw Operator; Drill Operator (hydraulic, diamond, aiartrac); Faller and Bucker Chain Saw; Grade Checker and Transit Person; Groutmen (pressure) including post tension beams; Hazardous Waste Worker (Level B: uses same respirator protection as Level A. A supplied air line is provided in conjunction with a chemical "splash suit"); High Scaler; Jackhammer; Laserbeam Operator; Manhole Builder-Mudman; Nozzleman (concrete pump, green cutter when using combination of high pressure air and water on concrete and rock, sandblast, gunite, shotcrete, water blaster, vacuum blaster); Pavement Breaker; Pipe Layer and Caulker; Pipe Pot Tender; Pipe Reliner (not insert type); Pipe Wrapper; Power Jacks; Railroad Spike Puller-Power; Raker-Asphalt; Rivet Buster; Rodder; Sloper (over 20 ft); Spreader (concrete); Tamper and Similar electric, air and glas operated tool; Timber Person-sewer (lagger shorer and cribber); Track Liner Power; Tugger Operator; Vibrator; Well Point Laborer

GROUP 5: Caisson Worker; Miner; Mortarman and Hodcarrier; Powderman; Re-Timberman; Hazardous Waste Worker (Level A: utilizes a fully encapsulated suit with a self-contained breathing apparatus or a supplied air line).

---



LABO0335-001 06/01/2020

CLARK, COWLITZ, KLICKITAT, PACIFIC (SOUTH OF A STRAIGHT LINE MADE BY EXTENDING THE NORTH BOUNDARY LINE OF WAHKIAKUM COUNTY WEST TO THE PACIFIC OCEAN), SKAMANIA AND WAHKIAKUM COUNTIES

	Rates	Fringes
Laborers:		
ZONE 1:		
GROUP 1.....	\$ 34.93	12.44
GROUP 2.....	\$ 35.65	12.44
GROUP 3.....	\$ 36.20	12.44
GROUP 4.....	\$ 36.66	12.44
GROUP 5.....	\$ 31.93	12.44
GROUP 6.....	\$ 29.01	12.44
GROUP 7.....	\$ 25.14	12.44

Zone Differential (Add to Zone 1 rates):

Zone 2 \$ 0.65

Zone 3 - 1.15

Zone 4 - 1.70

Zone 5 - 2.75

BASE POINTS: LONGVIEW AND VANCOUVER

ZONE 1: Projects within 30 miles of the respective city all.

ZONE 2: More than 30 miles but less than 40 miles from the respective city hall.

ZONE 3: More than 40 miles but less than 50 miles from the respective city hall.

ZONE 4: More than 50 miles but less than 80 miles from the respective city hall.

ZONE 5: More than 80 miles from the respective city hall.

#### LABORERS CLASSIFICATIONS

GROUP 1: Asphalt Plant Laborers; Asphalt Spreaders; Batch Weighman; Broomers; Brush Burners and Cutters; Car and Truck Loaders; Carpenter Tender; Change-House Man or Dry Shack Man; Choker Setter; Clean-up Laborers; Curing, Concrete; Demolition, Wrecking and Moving Laborers; Dumpers, road oiling crew; Dumpmen (for grading crew); Elevator Feeders; Median Rail Reference Post, Guide Post, Right of Way Marker; Fine Graders; Fire Watch; Form Strippers (not swinging stages); General Laborers; Hazardous Waste Worker; Leverman or Aggregate Spreader (Flaherty and similar types); Loading Spotters; Material Yard Man (including electrical); Pittsburgh Chipper Operator or Similar Types; Railroad Track Laborers; Ribbon Setters (including steel forms); Rip Rap Man (hand placed); Road Pump Tender; Sewer Labor; Signalman; Skipman; Slopers; Spraymen; Stake Chaser; Stockpiler; Tie Back Shoring; Timber Faller and Bucker (hand labor); Toolroom Man (at job site); Tunnel Bullgang (above ground); Weight-Man- Crusher (aggregate when used)

GROUP 2: Applicator (including pot power tender for same), applying protective material by hand or nozzle on utility lines or storage tanks on project; Brush Cutters (power saw); Burners; Choker Splicer; Clary Power Spreader and similar types; Clean- up Nozzleman-Green Cutter (concrete, rock, etc.); Concrete Power Buggyman; Concrete Laborer; Crusher Feeder; Demolition and Wrecking Charred Materials; Gunite Nozzleman Tender; Gunite or Sand Blasting Pot Tender; Handlers or Mixers of all Materials of an irritating nature (including cement and lime); Tool Operators (includes but not limited to: Dry Pack Machine; Jackhammer; Chipping Guns; Paving Breakers); Pipe Doping and Wrapping; Post Hole Digger, air, gas or electric; Vibrating Scream; Tampers; Sand Blasting (Wet); Stake-Setter; Tunnel-Muckers, Brakemen, Concrete Crew, Bullgang (underground)

GROUP 3: Asbestos Removal; Bit Grinder; Drill Doctor; Drill Operators, air tracks, cat drills, wagon drills, rubber-mounted drills, and other similar types including at crusher plants; Gunite Nozzleman; High Scalers, Strippers and Drillers (covers work in swinging stages, chairs or belts, under extreme conditions unusual to normal drilling, blasting, barring-down, or sloping and stripping); Manhole Builder; Powdermen; Concrete Saw Operator; Pwdermen; Power Saw Operators (Bucking and Falling); Pumpcrete Nozzlemen; Sand Blasting (Dry); Sewer Timberman; Track Liners, Anchor Machines, Ballast Regulators, Multiple Tampers, Power Jacks, Tugger Operator; Tunnel-Chuck Tenders, Nippers and Timbermen; Vibrator; Water Blaster

GROUP 4: Asphalt Raker; Concrete Saw Operator (walls); Concrete Nozzelman; Grade Checker; Pipelayer; Laser Beam (pipelaying)-applicable when employee assigned to move, set up, align; Laser Beam; Tunnel Miners; Motorman-Dinky Locomotive-Tunnel; Powderman-Tunnel; Shield Operator-Tunnel

GROUP 5: Traffic Flaggers

GROUP 6: Fence Builders

GROUP 7: Landscaping or Planting Laborers

-----  
LABO0335-019 06/01/2020

	Rates	Fringes
Hod Carrier.....	\$ 34.93	12.44

-----

LABO0348-003 06/01/2020

CHELAN, DOUGLAS (W OF 12TH MERIDIAN), KITTITAS, AND YAKIMA COUNTIES

	Rates	Fringes
LABORER		
GROUP 1.....	\$ 23.68	12.44
GROUP 2.....	\$ 27.17	12.44
GROUP 3.....	\$ 29.74	12.44
GROUP 4.....	\$ 30.46	12.44
GROUP 5.....	\$ 30.99	12.44

BASE POINTS: BELLINGHAM, MT. VERNON, EVERETT, SEATTLE, KENT, TACOMA, OLYMPIA, CENTRALIA, ABERDEEN, SHELTON, PT. TOWNSEND, PT. ANGELES, AND BREMERTON

ZONE 1 - Projects within 25 radius miles of the respective city hall  
 ZONE 2 - More than 25 but less than 45 radius miles from the respective city hall  
 ZONE 3 - More than 45 radius miles from the respective city hall

ZONE DIFFERENTIAL (ADD TO ZONE 1 RATES):  
 ZONE 2 - \$1.00  
 ZONE 3 - \$1.30

BASE POINTS: CHELAN, SUNNYSIDE, WENATCHEE, AND YAKIMA

ZONE 1 - Projects within 25 radius miles of the respective city hall  
 ZONE 2 - More than 25 radius miles from the respective city hall

ZONE DIFFERENTIAL (ADD TO ZONE 1 RATES):  
 ZONE 2 - \$2.25

LABORERS CLASSIFICATIONS

GROUP 1: Landscaping and Planting; Watchman; Window Washer/Cleaner (detail clean-up, such as but not limited to cleaning floors, ceilings, walls, windows, etc., prior to final acceptance by the owner)

GROUP 2: Batch Weighman; Crusher Feeder; Fence Laborer; Flagman; Pilot Car

GROUP 3: General Laborer; Air, Gas, or Electric Vibrating Screed; Asbestos Abatement Laborer; Ballast Regulator Machine; Brush Cutter; Brush Hog Feeder; Burner; Carpenter Tender; Cement Finisher Tender; Change House or Dry Shack; Chipping Gun (under 30 lbs.); Choker Setter; Chuck Tender; Clean-up Laborer; Concrete Form Stripper; Curing Laborer; Demolition (wrecking and moving including charred material); Ditch Digger; Dump Person; Fine Graders; Firewatch; Form Setter; Gabian Basket Builders; Grout Machine Tender; Grinders; Guardrail Erector; Hazardous Waste Worker (Level C: uses a chemical "splash suit" and air purifying respirator); Maintenance Person; Material Yard Person; Pot Tender; Rip Rap Person; Riggers; Scale Person; Sloper Sprayer; Signal Person; Stock Piler; Stake Hopper; Toolroom Man (at job site); Topper-Tailer; Track Laborer; Truck Spotter; Vinyl Seamer

GROUP 4: Cement Dumper-Paving; Chipping Gun (over 30 lbs.); Clary Power Spreader; Concrete Dumper/Chute Operator; Concrete Saw Operator; Drill Operator (hydraulic, diamond, aiartrac); Faller and Bucker Chain Saw; Grade Checker and Transit Person; Groutmen (pressure) including post tension beams; Hazardous Waste Worker (Level B: uses same respirator protection as Level A. A supplied air line is provided in conjunction with a chemical "splash suit"); High Scaler; Jackhammer; Laserbeam Operator; Manhole Builder-Mudman; Nozzleman (concrete pump, green cutter when using combination of high pressure air and water on concrete and rock, sandblast, gunite, shotcrete, water blaster, vacuum blaster); Pavement Breaker; Pipe Layer and Caulker; Pipe Pot Tender; Pipe Reliner (not insert type); Pipe Wrapper; Power Jacks; Railroad Spike Puller-Power; Raker-Asphalt; Rivet Buster; Rodder; Sloper (over 20 ft); Spreader (concrete); Tamper and Similar electric, air and glas operated tool; Timber Person-sewer (lagger shorer and cribber); Track Liner Power; Tugger Operator; Vibrator; Well Point Laborer

GROUP 5: Caisson Worker; Miner; Mortarman and Hodcarrier; Powderman; Re-Timberman; Hazardous Waste Worker (Level A: utilizes a fully encapsulated suit with a self-contained breathing apparatus or a supplied air line).

---

PAIN0005-002 07/01/2020

STATEWIDE EXCEPT CLARK, COWLITZ, KLICKITAT, PACIFIC (SOUTH),  
SKAMANIA, AND WAHAKIAKUM COUNTIES

	Rates	Fringes
Painters:		
STRIPERS.....	\$ 31.90	17.23

PAIN0005-004 03/01/2009

CLALLAM, GRAYS HARBOR, ISLAND, JEFFERSON, KING, KITSAP, LEWIS,  
MASON, PIERCE, SAN JUAN, SKAGIT, SNOHOMISH, THURSTON AND  
WHATCOM COUNTIES

	Rates	Fringes
PAINTER.....	\$ 20.82	7.44

\* PAIN0005-006 07/01/2018

ADAMS, ASOTIN; BENTON AND FRANKLIN (EXCEPT HANFORD SITE);  
CHELAN, COLUMBIA, DOUGLAS, FERRY, GARFIELD, GRANT, KITTITAS,  
LINCOLN, OKANOGAN, PEND OREILLE, SPOKANE, STEVENS, WALLA WALLA,  
WHITMAN AND YAKIMA COUNTIES

	Rates	Fringes
PAINTER		
Application of Cold Tar		
Products, Epoxies, Polyure		
thanes, Acids, Radiation		
Resistant Material, Water		
and Sandblasting.....	\$ 30.19	11.71
Over 30'/Swing Stage Work..	\$ 22.20	7.98
Brush, Roller, Striping,		
Steam-cleaning and Spray....	\$ 22.94	11.61
Lead Abatement, Asbestos		
Abatement.....	\$ 21.50	7.98

\*\$.70 shall be paid over and above the basic wage rates  
listed for work on swing stages and high work of over 30  
feet.



PAIN0055-003 07/01/2019

CLARK, COWLITZ, KLICKITAT, PACIFIC, SKAMANIA, AND WAHKIAKUM COUNTIES

	Rates	Fringes
PAINTER		
Brush & Roller.....	\$ 25.14	12.90
Spray and Sandblasting.....	\$ 25.14	12.90

All high work over 60 ft. = base rate + \$0.75

PAIN0055-006 03/01/2020

CLARK, COWLITZ, KLICKITAT, SKAMANIA and WAHKIAKUM COUNTIES

	Rates	Fringes
Painters:		
HIGHWAY & PARKING LOT		
STRIPER.....	\$ 35.87	13.40

PLAS0072-004 06/01/2020

ADAMS, ASOTIN, BENTON, CHELAN, COLUMBIA, DOUGLAS, FERRY, FRANKLIN, GARFIELD, GRANT, KITTITAS, LINCOLN, OKANOGAN, PEND OREILLE, SPOKANE, STEVENS, WALLA WALLA, WHITMAN, AND YAKIMA COUNTIES

	Rates	Fringes
CEMENT MASON/CONCRETE FINISHER		
ZONE 1.....	\$ 31.30	15.53

Zone Differential (Add to Zone 1 rate): Zone 2 - \$2.00

BASE POINTS: Spokane, Pasco, Lewiston; Wenatchee  
 Zone 1: 0 - 45 radius miles from the main post office  
 Zone 2: Over 45 radius miles from the main post office

PLAS0528-001 06/01/2020

CLALLAM, COWLITZ, GRAYS HARBOR, ISLAND, JEFFERSON, KING, KITSAP, LEWIS, MASON, PACIFIC, PIERCE, SAN JUAN, SKAGIT, SNOHOMISH, THURSTON, WAHKIAKUM AND WHATCOM COUNTIES

	Rates	Fringes
CEMENT MASON		
CEMENT MASON.....	\$ 45.80	18.54
COMPOSITION, TROWEL MACHINE, GRINDER, POWER TOOLS, GUNNITE NOZZLE.....	\$ 46.30	18.54
TROWELING MACHINE OPERATOR ON COMPOSITION.....	\$ 46.30	18.54

PLAS0555-002 07/01/2019

CLARK, KLICKITAT AND SKAMANIA COUNTIES

ZONE 1:

	Rates	Fringes
CEMENT MASON		
CEMENT MASONS DOING BOTH COMPOSITION/POWER MACHINERY AND SUSPENDED/HANGING SCAFFOLD..	\$ 37.32	18.77
CEMENT MASONS ON SUSPENDED, SWINGING AND/OR HANGING SCAFFOLD.....	\$ 36.58	18.77
CEMENT MASONS.....	\$ 35.85	18.77
COMPOSITION WORKERS AND POWER MACHINERY OPERATORS...	\$ 36.58	18.77

Zone Differential (Add To Zone 1 Rates):

- Zone 2 - \$0.65
- Zone 3 - 1.15
- Zone 4 - 1.70
- Zone 5 - 3.00

BASE POINTS: BEND, CORVALLIS, EUGENE, MEDFORD, PORTLAND, SALEM, THE DALLES, VANCOUVER

- ZONE 1: Projects within 30 miles of the respective city hall
- ZONE 2: More than 30 miles but less than 40 miles from the respective city hall.
- ZONE 3: More than 40 miles but less than 50 miles from the respective city hall.
- ZONE 4: More than 50 miles but less than 80 miles from the respective city hall.
- ZONE 5: More than 80 miles from the respective city hall

TEAM0037-002 06/01/2019

CLARK, COWLITZ, KLICKITAT, PACIFIC (South of a straight line made by extending the north boundary line of Wahkiakum County west to the Pacific Ocean), SKAMANIA, AND WAHKIAKUM COUNTIES

	Rates	Fringes
Truck drivers:		
ZONE 1		
GROUP 1.....	\$ 29.08	15.27
GROUP 2.....	\$ 29.20	15.27
GROUP 3.....	\$ 29.34	15.27
GROUP 4.....	\$ 29.62	15.27
GROUP 5.....	\$ 29.85	15.27
GROUP 6.....	\$ 30.03	15.27
GROUP 7.....	\$ 30.24	15.27

Zone Differential (Add to Zone 1 Rates):

- Zone 2 - \$0.65
- Zone 3 - 1.15
- Zone 4 - 1.70
- Zone 5 - 2.75

BASE POINTS: ASTORIA, THE DALLES, LONGVIEW AND VANCOUVER

ZONE 1: Projects within 30 miles of the respective city hall.

ZONE 2: More than 30 miles but less than 40 miles from the respective city hall.

ZONE 3: More than 40 miles but less than 50 miles from the respective city hall.

ZONE 4: More than 50 miles but less than 80 miles from the respective city hall.

ZONE 5: More than 80 miles from the respective city hall.

TRUCK DRIVERS CLASSIFICATIONS

GROUP 1: A Frame or Hydra lift truck w/load bearing surface; Articulated Dump Truck; Battery Rebuilders; Bus or Manhaul Driver; Concrete Buggies (power operated); Concrete Pump Truck; Dump Trucks, side, end and bottom dumps, including Semi Trucks and Trains or combinations there of: up to and including 10 cu. yds.; Lift Jitneys, Fork Lifts (all sizes in loading, unloading and transporting material on job site); Loader and/or Leverman on Concrete Dry Batch Plant (manually operated); Pilot Car; Pickup Truck; Solo Flat Bed and misc. Body Trucks, 0-10 tons; Truck Tender; Truck Mechanic Tender; Water Wagons (rated capacity) up to 3,000 gallons; Transit Mix and Wet or Dry Mix - 5 cu. yds. and under; Lubrication Man, Fuel Truck Driver, Tireman, Wash Rack, Steam Cleaner or combinations; Team Driver; Slurry Truck Driver or Leverman; Tireman

GROUP 2: Boom Truck/Hydra-lift or Retracting Crane; Challenger; Dumpsters or similar equipment all sizes; Dump Trucks/Articulated Dumps 6 cu to 10 cu.; Flaherty Spreader Driver or Leverman; Lowbed Equipment, Flat Bed Semi-trailer or doubles transporting equipment or wet or dry materials; Lumber Carrier, Driver-Straddle Carrier (used in loading, unloading and transporting of materials on job site); Oil Distributor Driver or Leverman; Transit mix and wet or dry mix trucks: over 5 cu. yds. and including 7 cu. yds.; Vacuum Trucks; Water truck/Wagons (rated capacity) over 3,000 to 5,000 gallons

GROUP 3: Ammonia Nitrate Distributor Driver; Dump trucks, side, end and bottom dumps, including Semi Trucks and Trains or combinations thereof: over 10 cu. yds. and including 30 cu. yds. includes Articulated Dump Trucks; Self-Propelled Street Sweeper; Transit mix and wet or dry mix truck: over 7 cu yds. and including 11 cu yds.; Truck Mechanic-Welder-Body Repairman; Utility and Clean-up Truck; Water Wagons (rated capacity) over 5,000 to 10,000 gallons

GROUP 4: Asphalt Burner; Dump Trucks, side, end and bottom dumps, including Semi-Trucks and Trains or combinations thereof: over 30 cu. yds. and including 50 cu. yds. includes Articulated Dump Trucks; Fire Guard; Transit Mix and Wet or Dry Mix Trucks, over 11 cu. yds. and including 15 cu. yds.; Water Wagon (rated capacity) over 10,000 gallons to 15,000 gallons

GROUP 5: Composite Crewman; Dump Trucks, side, end and bottom dumps, including Semi Trucks and Trains or combinations thereof: over 50 cu. yds. and including 60 cu. yds. includes Articulated Dump Trucks

GROUP 6: Bulk Cement Spreader w/o Auger; Dry Pre-Batch concrete Mix Trucks; Dump trucks, side, end and bottom dumps, including Semi Trucks and Trains of combinations thereof: over 60 cu. yds. and including 80 cu. yds., and includes Articulated Dump Trucks; Skid Truck

GROUP 7: Dump Trucks, side, end and bottom dumps, including Semi Trucks and Trains or combinations thereof: over 80 cu. yds. and including 100 cu. yds., includes Articulated Dump Trucks; Industrial Lift Truck (mechanical tailgate)

---

\* TEAM0174-001 06/01/2019

CLALLAM, GRAYS HARBOR, ISLAND, JEFFERSON, KING, KITSAP, LEWIS, MASON, PACIFIC (North of a straight line made by extending the north boundary line of Wahkiakum County west to the Pacific Ocean), PIERCE, SAN JUAN, SKAGIT, SNOHOMISH, THURSTON AND WHATCOM COUNTIES

	Rates	Fringes
Truck drivers:		
ZONE A:		
GROUP 1:.....	\$ 40.38	20.46
GROUP 2:.....	\$ 39.54	20.46
GROUP 3:.....	\$ 36.73	20.46
GROUP 4:.....	\$ 31.76	20.46
GROUP 5:.....	\$ 39.93	20.46

ZONE B (25-45 miles from center of listed cities\*): Add \$.70 per hour to Zone A rates.

ZONE C (over 45 miles from centr of listed cities\*): Add \$1.00 per hour to Zone A rates.

\*Zone pay will be calculated from the city center of the following listed cities:

BELLINGHAM	CENTRALIA	RAYMOND	OLYMPIA
EVERETT	SHELTON	ANACORTES	BELLEVUE
SEATTLE	PORT ANGELES	MT. VERNON	KENT
TACOMA	PORT TOWNSEND	ABERDEEN	BREMERTON

TRUCK DRIVERS CLASSIFICATIONS

GROUP 1 - "A-frame or Hydralift" trucks and Boom trucks or similar equipment when "A" frame or "Hydralift" and Boom truck or similar equipment is used; Buggymobile; Bulk Cement Tanker; Dumpsters and similar equipment, Tournorockers, Tournowagon, Tournotrailer, Cat DW series, Terra Cobra, Le Tourneau, Westinghouse, Athye Wagon, Euclid Two and Four-Wheeled power tractor with trailer and similar top-loaded equipment transporting material: Dump Trucks, side, end and bottom dump, including semi-trucks and trains or combinations thereof with 16 yards to 30 yards capacity: Over 30 yards \$.15 per hour additional for each 10 yard increment; Explosive Truck (field mix) and similar equipment; Hyster Operators (handling bulk loose aggregates); Lowbed and Heavy Duty Trailer; Road Oil Distributor Driver; Spreader, Flaherty Transit mix used exclusively in heavy construction; Water Wagon and Tank Truck-3,000 gallons and over capacity



GROUP 2 - Bulllifts, or similar equipment used in loading or unloading trucks, transporting materials on job site; Dumpsters, and similar equipment, Tournorockers, Tournowagon, Turnotrailer, Cat. D.W. Series, Terra Cobra, Le Tourneau, Westinghouse, Athye wagon, Euclid two and four-wheeled power tractor with trailer and similar top-loaded equipment transporting material: Dump trucks, side, end and bottom dump, including semi-trucks and trains or combinations thereof with less than 16 yards capacity; Flatbed (Dual Rear Axle); Grease Truck, Fuel Truck, Greaser, Battery Service Man and/or Tire Service Man; Leverman and loader at bunkers and batch plants; Oil tank transport; Scissor truck; Slurry Truck; Sno-Go and similar equipment; Swampers; Straddler Carrier (Ross, Hyster) and similar equipment; Team Driver; Tractor (small, rubber-tired) (when used within Teamster jurisdiction); Vacuum truck; Water Wagon and Tank trucks-less than 3,000 gallons capacity; Winch Truck; Wrecker, Tow truck and similar equipment

GROUP 3 - Flatbed (single rear axle); Pickup Sweeper; Pickup Truck. (Adjust Group 3 upward by \$2.00 per hour for onsite work only)

GROUP 4 - Escort or Pilot Car

GROUP 5 - Mechanic

#### HAZMAT PROJECTS

Anyone working on a HAZMAT job, where HAZMAT certification is required, shall be compensated as a premium, in addition to the classification working in as follows:

LEVEL C: +\$.25 per hour - This level uses an air purifying respirator or additional protective clothing.

LEVEL B: +\$.50 per hour - Uses same respirator protection as Level A. Supplied air line is provided in conjunction with a chemical "splash suit."

LEVEL A: +\$.75 per hour - This level utilizes a fully-encapsulated suit with a self-contained breathing apparatus or a supplied air line.

-----

TEAM0690-004 01/01/2019

ADAMS, ASOTIN, BENTON, CHELAN, COLUMBIA, DOUGLAS, FERRY, FRANKLIN, GARFIELD, GRANT KITTITAS, LINCOLN, OKANOGAN, PEND OREILLE, SPOKANE, STEVENS, WALLA WALLA, WHITMAN AND YAKIMA COUNTIES

	Rates	Fringes
Truck drivers: (AREA 1: SPOKANE ZONE CENTER: Adams, Chelan, Douglas, Ferry, Grant, Kittitas, Lincoln, Okanogan, Pen Oreille, Spokane, Stevens, and Whitman Counties		

AREA 1: LEWISTON ZONE CENTER:  
Asotin, Columbia, and  
Garfield Counties

AREA 2: PASCO ZONE CENTER:  
Benton, Franklin, Walla Walla  
and Yakima Counties)

AREA 1:		
GROUP 1.....	\$ 23.91	17.40
GROUP 2.....	\$ 26.18	17.40
GROUP 3.....	\$ 26.68	17.40
GROUP 4.....	\$ 27.01	17.40
GROUP 5.....	\$ 27.12	17.40
GROUP 6.....	\$ 27.29	17.40
GROUP 7.....	\$ 27.82	17.40
GROUP 8.....	\$ 28.18	17.40
AREA 2:		
GROUP 1.....	\$ 26.05	17.40
GROUP 2.....	\$ 28.69	17.40
GROUP 3.....	\$ 28.80	17.40
GROUP 4.....	\$ 29.13	17.40
GROUP 5.....	\$ 29.24	17.40
GROUP 6.....	\$ 29.24	17.40
GROUP 7.....	\$ 29.78	17.40
GROUP 8.....	\$ 30.10	17.40

Zone Differential (Add to Zone 1 rate: Zone 1 + \$2.00)

BASE POINTS: Spokane, Pasco, Lewiston

Zone 1: 0-45 radius miles from the main post office.

Zone 2: Outside 45 radius miles from the main post office

## TRUCK DRIVERS CLASSIFICATIONS

GROUP 1: Escort Driver or Pilot Car; Employee Haul; Power Boat Hauling Employees or Material

GROUP 2: Fish Truck; Flat Bed Truck; Fork Lift (3000 lbs. and under); Leverperson (loading trucks at bunkers); Trailer Mounted Hydro Seeder and Mulcher; Seeder & Mulcher; Stationary Fuel Operator; Tractor (small, rubber-tired, pulling trailer or similar equipment)

GROUP 3: Auto Crane (2000 lbs. capacity); Buggy Mobile & Similar; Bulk Cement Tanks & Spreader; Dumptor (6 yds. & under); Flat Bed Truck with Hydraulic System; Fork Lift (3001-16,000 lbs.); Fuel Truck Driver, Steamcleaner & Washer; Power Operated Sweeper; Rubber-tired Tunnel Jumbo; Scissors Truck; Slurry Truck Driver; Straddle Carrier (Ross, Hyster, & similar); Tireperson; Transit Mixers & Truck Hauling Concrete (3 yd. to & including 6 yds.); Trucks, side, end, bottom & articulated end dump (3 yards to and including 6 yds.); Warehouseperson (to include shipping & receiving); Wrecker & Tow Truck

GROUP 4: A-Frame; Burner, Cutter, & Welder; Service Greaser; Trucks, side, end, bottom & articulated end dump (over 6 yards to and including 12 yds.); Truck Mounted Hydro Seeder; Warehouseperson; Water Tank truck (0-8,000 gallons)

GROUP 5: Dumptor (over 6 yds.); Lowboy (50 tons & under); Self-loading Roll Off; Semi-Truck & Trailer; Tractor with Steer Trailer; Transit Mixers and Trucks Hauling Concrete (over 6 yds. to and including 10 yds.); Trucks, side, end, bottom and end dump (over 12 yds. to & including 20 yds.); Truck-Mounted Crane (with load bearing surface either mounted or pulled, up to 14 ton); Vacuum Truck (super sucker, guzzler, etc.)

GROUP 6: Flaherty Spreader Box Driver; Flowboys; Fork Lift (over 16,000 lbs.); Dumps (Semi-end); Mechanic (Field); Semi-end Dumps; Transfer Truck & Trailer; Transit Mixers & Trucks Hauling Concrete (over 10 yds. to & including 20 yds.); Trucks, side, end, bottom and articulated end dump (over 20 yds. to & including 40 yds.); Truck and Pup; Tournarocker, DWs & similar with 2 or more 4 wheel-power tractor with trailer, gallonage or yardage scale, whichever is greater Water Tank Truck (8,001- 14,000 gallons); Lowboy(over 50 tons)

GROUP 7: Oil Distributor Driver; Stringer Truck (cable operated trailer); Transit Mixers & Trucks Hauling Concrete (over 20 yds.); Truck, side, end, bottom end dump (over 40 yds. to & including 100 yds.); Truck Mounted Crane (with load bearing surface either mounted or pulled (16 through 25 tons);

GROUP 8: Prime Movers and Stinger Truck; Trucks, side, end,

bottom and articulated end dump (over 100 yds.); Helicopter Pilot Hauling Employees or Materials

Footnote A - Anyone working on a HAZMAT job, where HAZMAT certification is required, shall be compensated as a premium, in addition to the classification working in as follows:

LEVEL C-D: - \$.50 PER HOUR (This is the lowest level of protection. This level may use an air purifying respirator or additional protective clothing.

LEVEL A-B: - \$1.00 PER HOUR (Uses supplied air in conjunction with a chemical splash suit or fully encapsulated suit with a self-contained breathing apparatus.

Employees shall be paid Hazmat pay in increments of four(4) and eight(8) hours.

NOTE:

Trucks Pulling Equipment Trailers: shall receive \$.15/hour over applicable truck rate

-----  
WELDERS - Receive rate prescribed for craft performing operation to which welding is incidental.  
=====

Note: Executive Order (EO) 13706, Establishing Paid Sick Leave for Federal Contractors applies to all contracts subject to the Davis-Bacon Act for which the contract is awarded (and any solicitation was issued) on or after January 1, 2017. If this contract is covered by the EO, the contractor must provide employees with 1 hour of paid sick leave for every 30 hours they work, up to 56 hours of paid sick leave each year. Employees must be permitted to use paid sick leave for their own illness, injury or other health-related needs, including preventive care; to assist a family member (or person who is like family to the employee) who is ill, injured, or has other health-related needs, including preventive care; or for reasons resulting from, or to assist a family member (or person who is like family to the employee) who is a victim of, domestic violence, sexual assault, or stalking. Additional information on contractor requirements and worker protections under the EO is available at [www.dol.gov/whd/govcontracts](http://www.dol.gov/whd/govcontracts).

Unlisted classifications needed for work not included within the scope of the classifications listed may be added after award only as provided in the labor standards contract clauses (29CFR 5.5 (a) (1) (ii)).  
-----

The body of each wage determination lists the classification and wage rates that have been found to be prevailing for the cited type(s) of construction in the area covered by the wage determination. The classifications are listed in alphabetical order of ""identifiers"" that indicate whether the particular rate is a union rate (current union negotiated rate for local), a survey rate (weighted average rate) or a union average rate (weighted union average rate).

#### Union Rate Identifiers

A four letter classification abbreviation identifier enclosed in dotted lines beginning with characters other than ""SU"" or ""UAVG"" denotes that the union classification and rate were prevailing for that classification in the survey. Example: PLUM0198-005 07/01/2014. PLUM is an abbreviation identifier of the union which prevailed in the survey for this classification, which in this example would be Plumbers. 0198 indicates the local union number or district council number where applicable, i.e., Plumbers Local 0198. The next number, 005 in the example, is an internal number used in processing the wage determination. 07/01/2014 is the effective date of the most current negotiated rate, which in this example is July 1, 2014.

Union prevailing wage rates are updated to reflect all rate changes in the collective bargaining agreement (CBA) governing this classification and rate.

#### Survey Rate Identifiers

Classifications listed under the ""SU"" identifier indicate that no one rate prevailed for this classification in the survey and the published rate is derived by computing a weighted average rate based on all the rates reported in the survey for that classification. As this weighted average rate includes all rates reported in the survey, it may include both union and non-union rates. Example: SULA2012-007 5/13/2014. SU indicates the rates are survey rates based on a weighted average calculation of rates and are not majority rates. LA indicates the State of Louisiana. 2012 is the year of survey on which these classifications and rates are based. The next number, 007 in the example, is an internal number used in producing the wage determination. 5/13/2014 indicates the survey completion date for the classifications and rates under that identifier.

Survey wage rates are not updated and remain in effect until a new survey is conducted.

## Union Average Rate Identifiers

Classification(s) listed under the UAVG identifier indicate that no single majority rate prevailed for those classifications; however, 100% of the data reported for the classifications was union data. EXAMPLE: UAVG-OH-0010 08/29/2014. UAVG indicates that the rate is a weighted union average rate. OH indicates the state. The next number, 0010 in the example, is an internal number used in producing the wage determination. 08/29/2014 indicates the survey completion date for the classifications and rates under that identifier.

A UAVG rate will be updated once a year, usually in January of each year, to reflect a weighted average of the current negotiated/CBA rate of the union locals from which the rate is based.

---

## WAGE DETERMINATION APPEALS PROCESS

1.) Has there been an initial decision in the matter? This can be:

- \* an existing published wage determination
- \* a survey underlying a wage determination
- \* a Wage and Hour Division letter setting forth a position on a wage determination matter
- \* a conformance (additional classification and rate) ruling

On survey related matters, initial contact, including requests for summaries of surveys, should be with the Wage and Hour Regional Office for the area in which the survey was conducted because those Regional Offices have responsibility for the Davis-Bacon survey program. If the response from this initial contact is not satisfactory, then the process described in 2.) and 3.) should be followed.

With regard to any other matter not yet ripe for the formal process described here, initial contact should be with the Branch of Construction Wage Determinations. Write to:

Branch of Construction Wage Determinations  
Wage and Hour Division  
U.S. Department of Labor  
200 Constitution Avenue, N.W.  
Washington, DC 20210



2.) If the answer to the question in 1.) is yes, then an interested party (those affected by the action) can request review and reconsideration from the Wage and Hour Administrator (See 29 CFR Part 1.8 and 29 CFR Part 7). Write to:

Wage and Hour Administrator  
U.S. Department of Labor  
200 Constitution Avenue, N.W.  
Washington, DC 20210

The request should be accompanied by a full statement of the interested party's position and by any information (wage payment data, project description, area practice material, etc.) that the requestor considers relevant to the issue.

3.) If the decision of the Administrator is not favorable, an interested party may appeal directly to the Administrative Review Board (formerly the Wage Appeals Board). Write to:

Administrative Review Board  
U.S. Department of Labor  
200 Constitution Avenue, N.W.  
Washington, DC 20210

4.) All decisions by the Administrative Review Board are final.

=====

END OF GENERAL DECISION"